

Xerox ANS COBOL (for BPM/CP-V)

Xerox 550/560 and Sigma 5-9 Computers

Operations Reference Manual

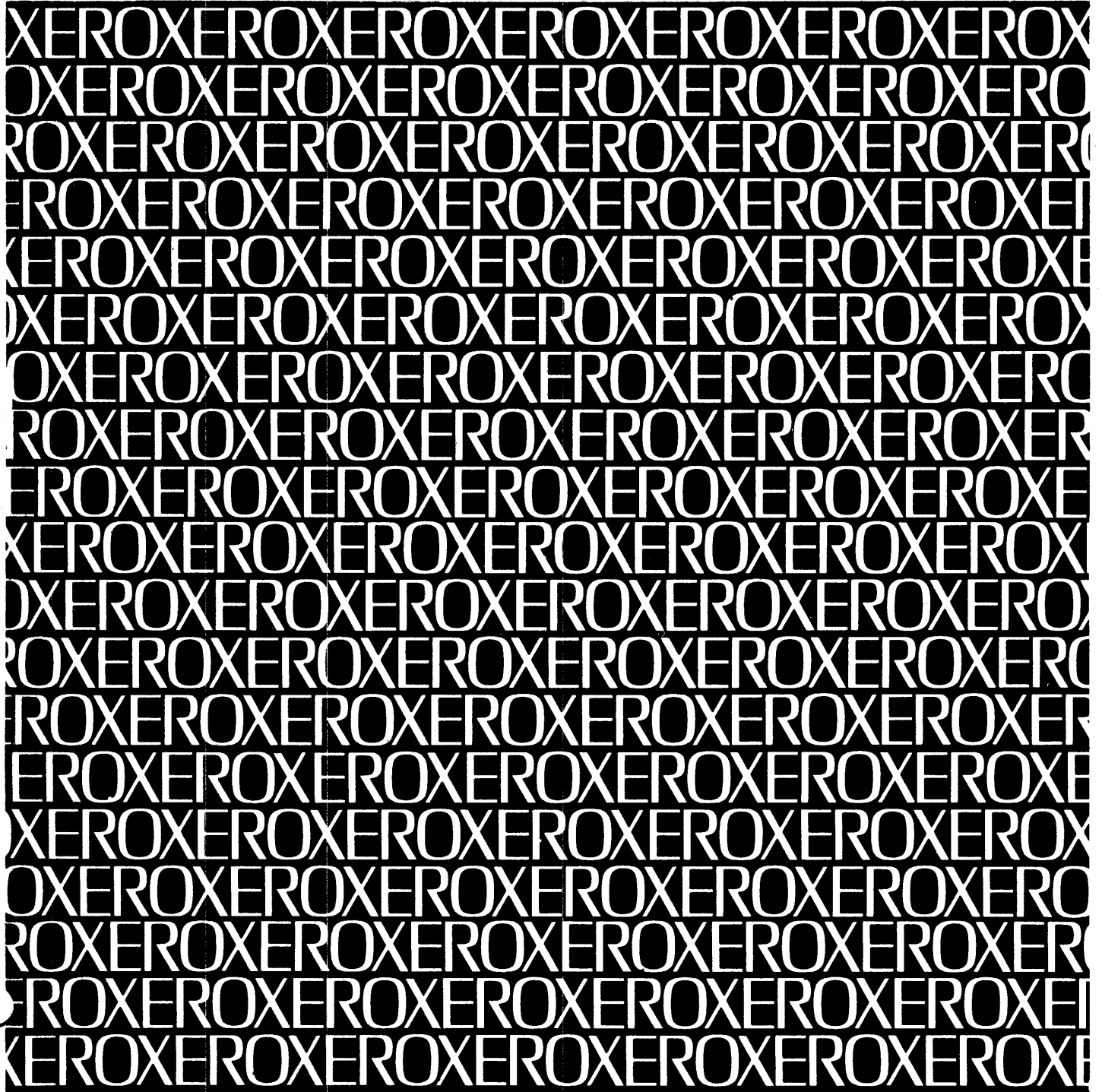

Xerox ANS COBOL (for BPM/CP-V)

Xerox 550/560 and Sigma 5-9 Computers

Operations Reference Manual

90 15 01G

May 1976

REVISION

This publication documents the E07 version of the Xerox ANS COBOL compiler for BPM and CP-V. This is the G edition of the manual; it is identical to the F edition (90 15 01F, dated September 1973) including all revision packages (90 15 01F-1, 3/74; -2, 5/74; and -3, 6/75), and serves to consolidate them. Vertical lines in the outer margin indicate changes made in the most recent revision.

RELATED PUBLICATIONS

<u>Title</u>	<u>Publication No.</u>
Xerox 550 Computer/Reference Manual	90 30 77
Xerox 560 Computer/Reference Manual	90 30 76
Xerox Sigma 5 Computer/Reference Manual	90 09 59
Xerox Sigma 6 Computer/Reference Manual	90 17 13
Xerox Sigma 7 Computer/Reference Manual	90 09 50
Xerox Sigma 8 Computer/Reference Manual	90 17 49
Xerox Sigma 9 Computer/Reference Manual	90 17 33
Xerox Batch Processing Monitor (BPM)/BP,RT Reference Manual	90 09 54
Xerox Batch Processing Monitor (BPM)/OPS Reference Manual	90 11 98
Xerox Control Program-Five (CP-V)/TS Reference Manual	90 09 07
Xerox Control Program-Five (CP-V)/OPS Reference Manual	90 16 75
Xerox Control Program-Five (CP-V)/TS User's Guide	90 16 92
Xerox Control Program-Five (CP-V)/SM Reference Manual	90 16 74
Xerox ANS COBOL (for BPM/CP-V)/LN Reference Manual	90 15 00
Xerox ANS COBOL On-Line Debugger Reference Manual	90 30 60
Xerox Sort and Merge (for BPM/CP-V)/Reference Manual	90 11 99
Xerox Data Management System (DMS) (for BPM/CP-V)/Reference Manual	90 17 38
Xerox Extended Data Management System (EDMS)/Reference Manual	90 30 12

Manual Content Codes: BP — batch processing, LN — language, OPS — operations, RP — remote processing, RT — real-time, SM — system management, SP — system programming, TP — transaction-processing, TS — time-sharing, UT — utilities.

The specifications of the software system described in this publication are subject to change without notice. The availability or performance of some features may depend on a specific configuration of equipment such as additional tape units or larger memory. Customers should consult their Xerox sales representative for details.

CONTENTS

<p>PREFACE v</p> <p>1. PROGRAMMING HINTS 1</p> <p style="padding-left: 20px;">Description of Numeric Data Items 1</p> <p style="padding-left: 40px;">Examples of a Decimal Add 1</p> <p style="padding-left: 20px;">Table Handling 2</p> <p style="padding-left: 20px;">OCCURS DEPENDING ON Clause 2</p> <p style="padding-left: 20px;">Sort 2</p> <p style="padding-left: 20px;">I/O Considerations 2</p> <p style="padding-left: 20px;">Report Writer 3</p> <p style="padding-left: 20px;">COBOL/FORTRAN Interfaces 3</p> <p>2. COMPILER 6</p> <p style="padding-left: 20px;">Compilation Initiation 6</p> <p style="padding-left: 40px;">BO (Binary Object Deck) 7</p> <p style="padding-left: 40px;">CS(name) (COMMON-STORAGE SECTION) 7</p> <p style="padding-left: 40px;">DEBUG (Debugging Statements) 7</p> <p style="padding-left: 40px;">DIAG (Trivial Diagnostics) 7</p> <p style="padding-left: 40px;">DMAP (Data Division Map) 7</p> <p style="padding-left: 40px;">DQ (Double Quotation Mark) 9</p> <p style="padding-left: 40px;">GO (Compile and Run) 9</p> <p style="padding-left: 40px;">LIB (Library Accounts) 9</p> <p style="padding-left: 40px;">LO (Object Listing) 9</p> <p style="padding-left: 40px;">LS (Source Listing) 9</p> <p style="padding-left: 40px;">MAIN (Main Program) 12</p> <p style="padding-left: 40px;">MAPS (Both Data Division Map and Procedure Division Map) 12</p> <p style="padding-left: 40px;">PMAP (Procedure Division Map) 12</p> <p style="padding-left: 40px;">SEG (Priority Segments) 12</p> <p style="padding-left: 40px;">SEQCHK (Sequence Check) 12</p> <p style="padding-left: 40px;">SO (Source Output) 12</p> <p style="padding-left: 40px;">SRTx (Co-Resident Sort) 13</p> <p style="padding-left: 40px;">SUB (Subprogram) 13</p> <p style="padding-left: 40px;">SYN (Syntax Checking) 13</p> <p style="padding-left: 40px;">TEST (On-Line Debugger) 13</p> <p style="padding-left: 40px;">XREF (Cross-Reference Listing) 13</p> <p>3. INTER-PROGRAM COMMUNICATION 14</p> <p style="padding-left: 20px;">Introduction 14</p> <p style="padding-left: 20px;">Rules for Usage 14</p> <p>4. OBJECT PROGRAM 16</p> <p style="padding-left: 20px;">Segmented Object Programs 16</p> <p style="padding-left: 20px;">Object Program Structure 16</p> <p>5. PROGRAM COMPILATION AND EXECUTION 18</p> <p style="padding-left: 20px;">Compilation of Large Source Programs 18</p> <p style="padding-left: 20px;">COBOL Work Files 18</p> <p style="padding-left: 20px;">COBOL Library on Tape 18</p> <p style="padding-left: 20px;">Print File Handling 18</p>	<p style="padding-left: 20px;">Deck Structures 20</p> <p style="padding-left: 40px;">Basic Setups 20</p> <p style="padding-left: 40px;">Segmentation Feature 25</p> <p style="padding-left: 40px;">Inter-Program Communication (Subcompile Feature) 31</p> <p style="padding-left: 40px;">ENTER Statement Feature 37</p> <p style="padding-left: 40px;">Co-Resident Sort Feature 40</p> <p style="padding-left: 40px;">Debug Module Object Time Switch 48</p> <p>6. XEROX ANS COBOL COMPILER DIAGNOSTICS 49</p> <p>7. RUN-TIME SUBROUTINES, SERVICES AND DIAGNOSTICS 65</p> <p style="padding-left: 20px;">Library Subroutines 65</p> <p style="padding-left: 40px;">Subprogram Calls 68</p> <p style="padding-left: 40px;">Special Interfaces to Hardware and Monitor Services 68</p> <p style="padding-left: 20px;">COBOL Error Codes 72</p> <p>INDEX 83</p> <p style="text-align: center;">APPENDIX</p> <p>REFERENCE TABLES 75</p> <p style="padding-left: 20px;">Standard Symbols and Codes 75</p> <p style="padding-left: 20px;">Standard Character Sets 75</p> <p style="padding-left: 20px;">Control Codes 75</p> <p style="padding-left: 20px;">Special Code Properties 75</p> <p style="padding-left: 20px;">Standard 8-Bit Computer Codes (EBCDIC) 76</p> <p style="padding-left: 20px;">Standard 7-Bit Communication Codes (ANSII)¹ 76</p> <p style="padding-left: 20px;">Standard Symbol-Code Correspondences 77</p> <p style="padding-left: 20px;">Hexadecimal Arithmetic 81</p> <p style="padding-left: 40px;">Addition Table 81</p> <p style="padding-left: 40px;">Multiplication Table 81</p> <p style="text-align: center;">FIGURES</p> <p>1. Sample Data Division Map Listing 8</p> <p>2. Sample (Partial) Object Listing 10</p> <p>3. Sample Source Program and Procedure Division Map Listing 11</p> <p>4. Sample Cross-Reference Listing 13</p>
--	--

5.	Standard Control Section of a Root Segment Module _____	17
6.	Load Module Map _____	17
7.	Basic Setup – Compilation Only _____	20
8.	Basic Setup – Compilation and Execution _____	21
9.	Basic Setup – Execution with Object Deck _____	24
10.	Segmentation Feature – Compilation and Execution _____	25
11.	Segmentation Feature – Load from BO File, Execute, and Punch BO File _____	27
12.	Segmentation Feature – Execution from Object Decks _____	29
13.	Inter-Program Communication – Compilation of Main or Calling Program _____	32
14.	Inter-Program Communication – Compilation of Subprogram or Called Program _____	33
15.	Inter-Program Communication – Execution with Object Decks _____	34

16.	Inter-Program Communication – Compilation and Execution _____	35
17.	ENTER Statement Feature – Compilation and Execution _____	37
18.	ENTER Statement Feature – Execution with Object Decks _____	39
19.	Co-Resident Sort Feature – Compilation and Execution (Sequential Sort Technique) _____	40
20.	Co-Resident Feature – Compilation and Execution (Random Sort Technique) _____	42

TABLES

1.	Xerox Buffered Line Printers Models 7440/7445 and 7446 Vertical-Format Control Codes _____	19
2.	Xerox ANS COBOL Compiler Diagnostics _____	49
3.	COBOL Object Program Subroutines _____	65
4.	COBOL Error Codes _____	72

PREFACE

This manual describes the operations and characteristics of the Xerox ANS COBOL system (under BPM and CP-V) including the compiler, library subroutines, and pertinent compiler and run-time diagnostics.

It is assumed that the reader has a good working knowledge of the COBOL language as described in the Xerox ANS COBOL (for BPM/CP-V) Reference Manual and of the operation of the Xerox Control Program-Five and/or the Xerox Batch Processing Monitor.

1. PROGRAMMING HINTS

This chapter provides a number of useful hints for improving the efficiency of object programs.

Description of Numeric Data Items

Avoid Mixed-Mode Arithmetic Statements. An arithmetic statement involving data items of more than one mode (binary, decimal, or floating) requires one or more relatively expensive conversions of the operands or the result. These conversions, which require run-time subroutines, are not needed when mixed-mode arithmetic statements are avoided.

Use Binary Rather Than Decimal Subscripts. The COBOL compiler requires that all subscripts be binary. The costly conversions of subscripts can be avoided if they are defined as binary rather than decimal.

Minimize Exponentiation. Exponentiation involves floating-point calculation mode even when there are no floating-point operands.

Use Binary Calculations if Possible. Binary calculations are faster than decimal or floating-point calculations and much faster than mixed mode. However, since binary items cannot contain a decimal point, their use is limited. If counters (i. e., input and output record counters) and subscripts are defined as binary data items, and other numeric data items as decimal, the number of costly conversions will generally be minimized without loss of the efficiencies of binary arithmetic.

Avoid Using Decimal Items Exceeding 15 Digits. Of the several ways to describe decimal items in COBOL, some permit the compiler to generate fewer instructions than others. For example, a data item containing 16, 17, or 18 decimal digits may require a double precision subroutine amounting to over 20 extra instructions not needed with items of 15 digits or less.

Specify Odd-Size Decimal Display Fields. Sigma pack and unpack instructions do not operate on even-sized decimal display fields. The compiler moves an even-sized display field to a work area in order to append a high-order zero, creating an odd-size field at a cost of three to six machine instructions. These extra instructions can be saved each time the field is referenced if it is odd-size to begin with.

Specify Packed Decimal if Possible. Packed decimal items occupy less space than decimal display items of the same size. Besides, they don't have to be packed and unpacked when used. Packed decimal, therefore, results in fewer instructions being generated for a given arithmetic statement.

Specify Signed Rather Than Unsigned Decimal Display Fields. The compiler must generate three instructions to get rid of the sign when a decimal field is described as unsigned. This applies each time the field is stored into.

To summarize, a decimal data item should be less than 16 digits long and have an odd number of digits. It should be described with a sign, and as packed decimal rather than decimal display.

Examples of a Decimal Add

Example 1:

77 A PIC 99.

77 B PIC 99.

ADD A TO B.

Seventeen instructions will be generated.

Example 2:

```
77    A    PIC S999 USAGE IS COMP-3.  
77    B    PIC S999 USAGE IS COMP-3.
```

ADD A TO B.

Three instructions will be generated.

Table Handling

Use indexes rather than subscripts for referencing data items described with or subordinate to one or more OCCURS clauses. With a subscript, the displacement into the table must be calculated (subscript x entry size - entry size) each time the table item is referenced. With indexing, this calculation is made only once when the index is set. In addition, when a table is described with an INDEXED BY clause, the SEARCH statement can be used on that table, and the search routine generated by the compiler will be more efficient than one written by the programmer.

Subscripts, if used, should be in binary since decimal subscripts are converted to binary anyway.

OCCURS DEPENDING ON Clause

Keep the use of this clause to a minimum. The OCCURS DEPENDING ON clause can be used effectively with variable length records to reduce the physical size of files and save I/O time. However, the clause will increase execution time because any reference to data item with an OCCURS DEPENDING ON clause requires that its size be calculated each time it is referenced. On balance, therefore, it is recommended that the use of OCCURS DEPENDING ON be kept to a minimum.

Sort

If a program has an input or output procedure, or both, either the co-resident or the linked sort can be requested. The co-resident sort, which occupies core memory at the same time as the COBOL program, can significantly reduce the number of input/output operations and, hence, run-time. It should, therefore, be used when core memory is available.

When linked sort is used, the RELEASE statements in the COBOL input procedure build a file as an interface for the linked sort. When the input procedure is finished, sort replaces the COBOL program in memory (i.e., the COBOL object program is swapped out), and sorts the file created by the input procedure into a new file, whereupon the COBOL program is brought back into core memory, replacing the sort. The RETURN statements of the output procedure read the sorted file.

Co-resident sort avoids superfluous reading and writing of the two files used by sort. When the SORT verb is encountered, control is transferred to sort. Then, when sort wants to read a record, it gives control to the COBOL input procedure, which provides a record through the use of the RELEASE statement. When sort wants to write the sorted file, it gives control to the COBOL output procedure, which accepts the sorted record with RETURN statements. Thus, unnecessary input/output is avoided.

I/O Considerations

Block Sequential Files. Blocking sequential files can shorten I/O and CPU times by reducing the number of physical records and increasing their size. It lessens start/stop times for tapes and compute time for setting up the I/O operations. A block size of 5000 to 7000 bytes is recommended.

Use Unlabeled or ANS-Labeled Tapes Rather Than Labeled Tapes. The monitor attaches control information to records written to labeled tape, but not to device tape or ANS-labeled tape. In addition, I/O on device tape of ANS-labeled tape is double-buffered. This allows I/O operations and CPU operations to overlap.

Avoid the INTO Option of the READ Statement and the FROM Option of the WRITE Statement. Working from record areas rather than moving the records to and from working storage reduces program run time. In some cases where a master file is updated, moving the input master record to the output master record can be avoided. This is accomplished with the SAME RECORD AREA statement that allows a record to be read, updated, and written with no record movement by the programmer. It also reduces the size of the program.

Block Relative Files. The monitor always reads or writes a minimum of one granule (512 words, 2048 bytes) from or to a relative file. The BLOCK CONTAINS clause of COBOL should be used to obtain a physical record size which is a multiple of granule size. This will insure optimum utilization of disk space and maximum speed. The COBOL I/O system will locate the proper granule/block and retrieve the user's record based on the relative record number supplied.

Note: To remove a record from a relative file place a X'FF00' in byte 1 of the record. This will signal the COBOL I/O system that this record is a null or deleted one. All records not written when the file is created are set to null by the system.

Report Writer

A report restart facility can be provided by programming around the OPEN statement for the report file which is being restarted. No abort will occur. The programmer can accept a page start parameter from a control card, count the pages skipped and when the start page is reached the logic can then go to the OPEN and start printing. No other program logic needs to be altered.

The OPEN can also be circumvented for the case where there are multiple FDs for a given RD and the suppression of its output to a file is desired.

COBOL/FORTRAN Interfaces

COBOL to FORTRAN

It is possible for COBOL to "call" FORTRAN subprograms by means of the ENTER verb. However, certain setup routines must be called and temp variables initialized before the FORTRAN library routines can be utilized. This initialization process is triggered by the COBOL program having the statement:

```
ENTER FORTLINK
```

This is done prior to the first call to a FORTRAN subprogram.

In addition to the ENTER list of arguments, the COBOL program may contain a COMMON-STORAGE SECTION. This generates a DSECT which can be referenced in the FORTRAN subprograms by means of the statement:

```
COMMON/TALLY/TALLY, ....
```

Note that the first word of TALLY cannot be referenced in the COBOL program and is not initialized.

The COBOL CS option permits use of a name other than TALLY for the common-storage DSECT.

FORTRAN to COBOL

Calling COBOL programs from FORTRAN programs has some restrictions. First, no arguments may be specified, data communication must be via named common, as indicated above. Second, COBOL does not have a verb equivalent to RETURN in FORTRAN. Third, the CALL statement in FORTRAN will use register 15 for its linkage, therefore it must be saved before the COBOL program starts executing.

In order to achieve the FORTRAN to COBOL linkage it is necessary to use a METASYMBOL routine to save register 15 upon entry into the COBOL routine and to exit from the COBOL routine. The entry point in the COBOL routine that is used in the FORTRAN CALL statement must be DEFed by using it in an ENTER COBOL statement.

The METASYMBOL routine should be coded like this:

	SYSTEM	SIG7	
	DEF	SAVEREG	
	DEF	RETNREG	
S15	RES	1	
SAVEREG	STW,15	S15	SAVE REGISTER 15
	B	*11	RETURN TO COBOL
RETNREG	B	*S15	RETURN TO FORTRAN
	END		

To use the METASYMBOL routine GO TO statements are required in the COBOL routine to go to the two entry points.

Demonstration Job

The following job has been written to illustrate COBOL/FORTRAN interfaces.

```

!JOB XEROX,COBOL,7 . COBOL/FORTRAN
!TITLE COBOL TO FORTRAN
!COBOL LS,LO,GO
  IDENTIFICATION DIVISION.
  PROGRAM-ID. COB:S.
  DATE-WRITTEN. DEC 12, 1974.
  DATE-COMPILED.
  REMARKS. COBOL TO FORTRAN AND ENTRY FOR FORTRAN.

  ENVIRONMENT DIVISION.
  CONFIGURATION SECTION.
  SOURCE-COMPUTER. XEROX-560.
  OBJECT-COMPUTER. XEROX-560.
  INPUT-OUTPUT SECTION.
  FILE-CONTROL.

  DATA DIVISION.
  WORKING-STORAGE SECTION.
  77 I1 COMP VALUE 1.
  77 I2 COMP VALUE 2.
  77 I3 COMP VALUE 3.
  COMMON-STORAGE SECTION.
  77 J1 COMP VALUE 11.
  77 J2 COMP VALUE 12.
  77 J3 COMP VALUE 13.

  PROCEDURE DIVISION.
  S-1.
    ENTER FORTLINK.
    ENTER FTEST1 I1,I2,I3.
    ENTER FTEST2.
    STOP RUN.
    ENTER COBOL CTEST.
  CTEST.
    GO TO SAVEREG.
    DISPLAY 'CTEST ENTERED' UPON PRINTER.
    GO TO RETNREG.

```

```
!FORTRAN LS,LO,GO,S  
SUBROUTINE FTEST1 (I1, I2, I3)
```

```
C THIS IS CALLED BY COBOL
```

```
COMMON/TALLY/TALLY,J1,J2,J3  
OUTPUT I1,I2,I3,J1,J2,J3  
RETURN
```

```
SUBROUTINE FTEST2
```

```
C THIS CALLS COBOL
```

```
OUTPUT 'FTEST2 RUNNING'  
CALL CTEST  
OUTPUT 'RETURN FROM CTEST'  
STOP
```

```
END
```

2. COMPILER

This chapter describes various compilation options, the compiler outputs, and pertinent compile-time diagnostic messages.

Compilation Initiation

A COBOL processor control command must initiate each Xerox ANS COBOL compilation job. The format of the command is

```
ICOBOL s1,s2,s3,...,sn
```

where

s_i may specify any of the following output options:

BO	Permanent copy of the object program via the BO (Binary Output) device.
CS(name)	COMMON-STORAGE SECTION name (see "Object Program Structure" in Chapter 4).
DEBUG	Source program debugging statements (TRACE, EXHIBIT).
DIAG	Trivial diagnostic messages.
DMAP	Data Division Map.
DQ	Double quotation mark.
GO	Load-and-go copy of the object program via the GO device.
LIB(accounts)	Library accounts.
LO	An object program listing.
LS	A source program listing.
MAIN	Main program (see "Inter-Program Communication" in Chapter 3).
MAPS	Both Data Division Map and Procedure Division Map.
PMAP	Procedure Division Map.
SEG	Priority segments (see "Segmented Object Programs" in Chapter 3 and "Segmentation Feature" in Chapter 5).
SEQCHK	Sequence check.
SO	Source output.
SRTx	Co-resident sort.
SUB	Subprogram (suppresses generation of "END start").
SYN	Compilation for syntax checking only (no code generation).
TEST	On-line debugger.
XREF	A cross-reference listing.

The processor control command may be written in free form. Any number of spaces may appear between ICOBOL and the specification string. Spaces are permitted before or after each option, but the option itself may not contain embedded spaces.

The specification string may be continued in one or more commands following the !COBOL control command. Continuation is specified by placing a semicolon at any point where a blank is legal. Position 1 of the continuation commands must be blank.

Specification sequence may vary. If no specifications are entered for the COBOL command, the options

LS, BO

are assumed. If any option is specified, all desired options must be specified.

BO (Binary Object Deck)

This option specifies that relocatable object modules (ROMs) of the compiled program are to be produced in binary form.

CS(name) (COMMON-STORAGE SECTION)

This option specifies the name to be used in the object program for the dummy program section that represents the COMMON-STORAGE SECTION. If this option is not specified, the name TALLY is used. If a name is used it is restricted to a maximum of 7 characters.

DEBUG (Debugging Statements)

This option specifies that debugging statements TRACE and EXHIBIT are to be included in the compilation. Absence of this option enables debugging statements to be suppressed at compilation time. Thus it is not necessary to delete these statements from the source program when it is recompiled to obtain an operational object program. For a complete description of debugging statements refer to Chapter 12 of the Xerox ANS COBOL (for BPM/CP-V)/LN Reference Manual, 90 15 00.

DIAG (Trivial Diagnostics)

This option specifies that trivial (warning) diagnostics also are to be listed along with the other diagnostics. These trivial diagnostics do not affect generation of the object program, but merely serve as warnings to the programmer. Examples of trivial diagnostics are

- INCORRECT PUNCTUATION
- EXTERNAL REFERENCE GENERATED
- RIGHTMOST AND/OR FRACTIONAL DIGITS TRUNCATED
- LEFTMOST DIGITS/CHARACTERS TRUNCATED
- INTEGER AND FRACTIONAL DIGITS TRUNCATED

DMAP (Data Division Map)

This option specifies that the Data Division Map is to be produced. This Map is an alphabetical list of the data-names along with their sizes and relative locations. Figure 1 shows a sample Data Division Map listing. The following information appears on the listing:

Line number	Corresponds to the source line number where the data-name is defined.
Data-name	The data-name as it appears in the DATA DIVISION.
Relative location	The displacement from the origin of the base section in the object program. Example: If the origin of the base section in the object program was hexadecimal location '03C00' and the relative location of the data-name was '0058 3', this means the data-name begins in byte 3 of hexadecimal location '03C58'.
Size	The size of the data-name in bytes.

```

00015      000120 DATA DIVISION.
00016      000130 FILE SECTION.
00017      000140 FD  IN-FILE LABEL RECORDS ARE STANDARD DATA RECORD IS IN-REC.
00018      000150 01 IN-REC.
00019      000160 02 WEEK          PICTURE 9.
00020      000170 02 DEPP          PICTURE 9.
00021      000180 02 TYPE-RUN      PICTURE A(10).
00022      000190 02 PROG          PICTURE X(4).
00023      000200 02 DATE          PICTURE X(5).
00024      000210 02 FILLER        PICTURE X(7).
00025      000220 02 MINUTES       PICTURE 99999.
00026      000230 02 CHARGE        PICTURE 999999.
00027      000231 02 FILLER        PICTURE X(43).
00028      000240 FD  REP-FILE LABEL RECORDS ARE OMITTED REPORT IS USAGE-REPORT.
00029      000250 FD  PRINT-FILE LABEL RECORD OMITTED DATA RECORD D-REC.
00030      000260 01 D-REC PICTURE X(120).
00031      000261 FD  TAPE-FILE
00032      000262 LABEL RECORD IS LABEL1
00033      000263 DATA RECORD IS TAPEREC.
00034      000264 01 TAPEREC PICTURE X(10).
00035      000265 01 LABEL1 PICTURE X(20).
00036      000270 WORKING-STORAGE SECTION.
00037      000280 77 MONTH PICTURE X(9).
00038      000290 77 COUNT PICTURE 9 VALUE 1.
00039      000300 77 CONT PICTURE X(11).
00040      000310 77 SAVE-DEP PICTURE 9 VALUE 0.
00041      000311 77 DEP PICTURE 9.
00042      000320 01 DEP-NAMES.
00043      000330 02 FILLER PICTURE A(11) VALUE 'ENGINEERING'.
00044      000340 02 FILLER PICTURE A(11) VALUE 'SALES'.
00045      000350 02 FILLER PICTURE A(11) VALUE 'ACCOUNTING'.
00046      000360 01 D-NAMES REDEFINES DEP-NAMES.
00047      000370 02 NAME PICTURE A(11) OCCURS 3 TIMES.

```

COBOL DATA DIVISION MAP LISTING

21:42 MAR 12, 1975

PAGE 1

LINE-NO	DATA-NAME	REL-LOC	SIZE	RECORD-NAME	BASE-NAME
00026	CHARGE	00008	5	IN-REC	IN-FILE
00039	CONT	00004	11		WORKING-STORAGE
00038	COUNT	00003	1		WORKING-STORAGE
00046	D-NAMES	0000A	33		WORKING-STORAGE
00030	D-REC	00000	120		PRINT-FILE
00023	DATE	00004	5	IN-REC	IN-FILE
00041	DEP	00008	1		WORKING-STORAGE
00042	DEP-NAMES	0000A	33		WORKING-STORAGE
00020	DEPP	00000 1	1	IN-REC	IN-FILE
00017	IN-FILE				FD - FILE
00018	IN-REC	00000	80		IN-FILE
00035	LABEL1	00000	20		TAPE-FILE
00025	MINUTES	00007	4	IN-REC	IN-FILE
00037	MONTH	00000	9		WORKING-STORAGE
00047	NAME	0000A	11	D-NAMES	WORKING-STORAGE
00029	PRINT-FILE				FD - FILE
00022	PROG	00003	4	IN-REC	IN-FILE
00028	REP-FILE				FD - FILE
00040	SAVE-DEP	00007	1		WORKING-STORAGE
00048	TALLY	00000	3		COMMON-STORAGE
00033	TAPE-FILE				FD - FILE
00034	TAPEREC	00000	10		TAPE-FILE
00021	TYPE-RUN	00000 2	10	IN-REC	IN-FILE
00019	WEEK	00000	1	IN-REC	IN-FILE

Figure 1. Sample Data Division Map Listing

Record name	The name of the record (level 01) to which the data-name belongs.
Base name	The base section (corresponding to DSECTs in the object program) to which the data-name belongs. A base section is created for WORKING-STORAGE and each file-name defined in the source program.

DQ (Double Quotation Mark)

This option informs the compiler that the source program to be compiled uses the double quotation mark (") exclusively, instead of the single quotation mark ('). If this option is not specified, the single quotation mark is assumed. The Hollerith code for the double quotation mark is a multipunched 8-7 (hexadecimal 7F). The Hollerith code for the single quotation mark is a multipunched 8-5 (hexadecimal 7D).

GO (Compile and Run)

This option specifies that the source program is to be compiled and then executed. The load-and-go copy of the object program is transmitted to the monitor GO file. The GO option also must be specified on the monitor !LOAD control command.

LIB (Library Accounts)

This option specifies optional account numbers which may contain library source files that are needed to satisfy COPY statements in the source program. This permits library files of other accounts to be accessed. Up to three optional accounts may be specified.

Example: !COBOL LS, LIB(ACC85011, TESTA, 90301)

This LIB option instructs the compiler to search accounts ACC85011, TESTA, or 90301 for those library files that do not exist under the user's own account number.

Library files on labeled tape may also be accessed. (See "COBOL Library on Tape" in Chapter 3.)

LO (Object Listing)

- This option specifies that a listing of the object program is to be output on the LO device. Figure 2 illustrates a sample object listing, which is keyed to the source program by line number and resembles an assembly language listing.

LS (Source Listing)

The source listing is output to the LO (Listing Output) device whenever the COBOL command specifies (explicitly or implicitly) the LS option.

Figure 3 depicts a sample Xerox ANS COBOL source program and Procedure Division Map listing with diagnostics immediately following the source lines containing errors. The COBOL processor control command is presented as the initial line of the listing. Each subsequent line contains a line number appearing in two parts separated by a period: the first number represents the position of the line in the source program as obtained from the SI (source input) device; the second number (subnumber) denotes lines inserted into the source program as a result of library retrieval statements (COPY or COPY REPLACING) in the source program.

Whenever the compiler detects an error in the source program, a diagnostic message and its message number are printed on the source listing immediately following the line containing the error. If the COBOL control command neither specifies nor implies the LS option, only the number of the line to which the diagnostic relates, the message number, and the message itself are printed. The number of diagnostic messages issued and the highest diagnostic severity level are printed at the end of the source listing. A complete listing of compiler diagnostics is shown in Chapter 5 of this manual.

***** ROOT SEGMENT *****

```

DEF TALLY
00000 DSECT 0 SIZE IS 3
00000 ORG TALLY
DEF INPUT-DEVICE
00000 DSECT 0 SIZE IS 80
DEF I: INPUT-DEVICE
00000 DSECT 0 SIZE IS 28
00000 ORG I: INPUT-DEVICE
DEF F: INPUT-DEVICE
00000 00000000 DATA,4 F: INPUT-DEVICE+X'00000000'
00001 02000000 A DATA,4 X'02000000'
00002 00000000 A DATA,4 X'00000000'
00003 00000000 A DATA,4 X'00000000'
00004 00000000 A DATA,4 X'00000000'
00005 00000000 A DATA,4 X'00000000'
00006 00A00000 DATA,4 INPUT-DEVICE+X'00A00000'
00000 DSECT 2 SIZE IS 208
00000 ORG F: INPUT-DEVICE *ZERO WORDS NOT PRINTED*
00000 34000003 A DATA,4 X'34000003'
00001 10020009 A DATA,4 X'10020009'
00002 10000000 DATA,4 INPUT-DEVICE+X'10000000'
00003 00A00000 X DATA,4 C: ERA+X'00A00000'
00004 00000000 X DATA,4 C: ABA+X'00000000'
00005 80000011 A DATA,4 X'80000011'
00006 00000016 DATA,4 F: INPUT-DEVICE+X'00000016'
0000A 0000002C DATA,4 F: INPUT-DEVICE+X'0000002C'
00016 01000008 A DATA,4 X'01000008'
0001F 02000002 A DATA,4 X'02000002'
00022 03000002 A DATA,4 X'03000002'
00025 04000002 A DATA,4 X'04000002'

00069 77360000 X UNPK,3 C: TLBL,3
0006A 72A60001 X LB,10 C: TLBL+X'1',3
0006B 49A00019 OR,10 BASE+X'19'
0006C 75A60001 X STB,10 C: TLBL+X'1',3
00040 00008 ORG BASE+X'8'
00008 01000000 X DATA,4 BA(C: TLBL)+X'01000000'
0006D 32300008 LW,3 BASE+X'8'
0006E 222005A8 LI,2 BA(BASE)+X'5A8'
0006F 61200000 A MBS,2 0
00070 EAB00025 BAL,11 *BASE+X'25'
00025 ORG BASE+X'25'
00042 00025 DATA,4 BASE+X'00000071'
00071 22200001 A LI,2 1
00072 76340000 X PACK,3 C: TLBL,2
00073 7F00003E DST,0 BASE+X'3E'
00074 76300016 PACK,3 BASE+X'16'
00075 7D00003E DC,0 BASE+X'3E'
00076 6930007F BNE $+9
00043 00009 ORG BASE+X'9'
00009 2B000000 DATA,4 BA(OUTPUTTHREE)+X'2B000000'
00077 32300009 LW,3 BASE+X'9'
00078 222005A9 LI,2 BA(BASE)+X'5A9'
00079 61200000 A MBS,2 0
0007A 22A00025 A LI,10 37
0007B 75A00003 A STB,10 3
0007C 32100003 A LW,1 3
0007D 61000061 MBS,0 BA(BASE)+X'61'
0007E 6800007F B $+1
00043 0007F EAB00026 BAL,11 *BASE+X'26'
00026 ORG BASE+X'26'
00047 00026 DATA,4 BASE+X'00000080'
00080 22E00001 A LI,14 1
00081 22600000 LI,6 I: INPUT-DEVICE
00082 6AB00000 X BAL,11 C: OPN
00048 00083 6AB00000 X BAL,11 C: BBF
00084 35B00025 STW,11 BASE+X'25'
00085 6AB00067 BAL,11 BASE+X'67'
00086 22E08002 A LI,14 32770
00087 22600000 LI,6 I: OUTPUTONE

```

Figure 2. Sample (Partial) Object Listing

```

00000          COBOL LS,LO,XREF,DIAG,PMAP
00001          000010 IDENTIFICATION DIVISION.
00002          000020 PROGRAM-ID. SEQUENTIAL-I-O-TEST.
00003          AUTHOR. XEROX CORPORATION.
00004          000040 DATE-WRITTEN. DECEMBER 7 1974.
00005          000050 ENVIRONMENT DIVISION.
00006          000060 CONFIGURATION SECTION.
00007          SOURCE-COMPUTER. XEROX-560.
00008          OBJECT-COMPUTER. XEROX-560.
00009          000090 INPUT-OUTPUT SECTION.
00010          000100 FILE-CONTROL.
00011          000110     SELECT INPUT-DEVICE ASSIGN TO CARD-READER.
00012          000120     SELECT OUTPUTONE     ASSIGN TO MAGNETIC-TAPE.
00013          000130     SELECT OUTPUTTWO ASSIGN TO DISC.
00014          000140     SELECT OUTPUTTHREE ASSIGN TO PRINTER.
00015          000145     SELECT OPTIONAL OP-FILE ASSIGN TO MAGNETIC-TAPE RESERVE 2
00016          000146     ALTERNATE AREAS.
00017          000147     SELECT ERROR-FILE ASSIGN TO
00018          000150 DATA DIVISION.
**** 022 **** NAME INVALID/OMITTED
**** 049 **** SYNTACTICAL ERROR
00019          000160 FILE SECTION.
00020          000170 FD INPUT-DEVICE LABEL RECORD OMITTED DATA RECORD INP.
00021          000180     01 INP PICTURE X(80).
00022          000190 FD OUTPUTONE LABEL RECORD STANDARD DATA RECORD OUT1.
00023          000210     01 OUT1 PICTURE X(80).
00024          000220 FD OUTPUTTWO LABEL RECORD STANDARD DATA RECORD OUT2.
00025          000240     01 OUT2 PICTURE X(80).
00026          000250 FD OUTPUTTHREE LABEL RECORD OMITTED DATA RECORD OUT3.
00027          000260     01 OUT3 PICTURE X(80).
00028          000261 FD OP-FILE LABEL RECORD IS STANDARD DATA RECORD IS OP-REC.
00029          000262 01 OP-REC PICTURE X(80).
00030          000263 FD ERROR-FILE LABEL RECORD IS DATUM DATA RECORD IS ERROR-REC.
00031          000264 01 ERROR-REC PICTURE X(80).
00032          000265 01 DATUM COPY LIB1.
00032.00001          01 DATUM.
00032.00002          02 DATA-0 PICTURE X.
00032.00003          02 DATA-1 PICTURE 9(5).
00033          000267 WORKING-STORAGE SECTION.
00034          000268     77 DATA-2 PICTURE 9(5) VALUE 123456.
**** 107 **** VALUE TRUNCATED ON LEFT
00035          000270 PROCEDURE DIVISION.
00036          000271 DECLARATIVES.
00037          000272 SEC-1 SECTION. USE AFTER STANDARD ERROR PROCEDURE ON ERROR-FILE.
00038          0005E 000273 P1. DISPLAY ERROR-REC.
00039          000274 S2 SECTION. USE BEFORE BEGINNING FILE LABEL PROCEDURE ON OUTPUT.
00040          00067 000275 P1. MOVE DATA-2 TO DATA-1. MOVE ' ' TO DATA-0.
00041          000276 S3 SECTION. USE AFTER BEGINNING FILE LABEL PROCEDURE ON INPUT.
00042          00071 000277 P1. IF DATA-1 = DATA-2 MOVE ' TEST TO READ AND CHECK USER LABEL
00043          00077 000278- 'SUCCESS' TO OUT3 ELSE EXHIBIT NAMED DATA-1 DATA-2.
00044          000279 END DECLARATIVES.
00045          000280 SEC-4 SECTION.
00046          000281 START.
00047          00080 000290 OPEN INPUT INPUT-DEVICE.
00048          00083 000300 OPEN OUTPUT OUTPUTONE, OUTPUTTWO,
00049          000310 OUTPUTTHREE, ERROR-FILE.
00050          0009B 000320 MOVE ' BEGIN SEQUENTIAL IO TEST ',TO OUT3.
**** 002 **** INCORRECT PUNCTUATION
**** 002 **** INCORRECT PUNCTUATION
00051          000A2 000330 WRITE OUT3.
00052          000331 CHECK-USE-VERB-FORMAT-2.
00053          000A7 000332 MOVE ' TEST TO READ AND CHECK USER LABEL FAILURE' TO OUT3.
00054          000AE 000333 MOVE ' THIS IS RECORD 1' TO ERROR-REC.
00055          000B5 000334 WRITE ERROR-REC CLOSE ERROR-FILE.
00056          000C3 000335 ADD 5 TO DATA-1 OPEN INPUT ERROR-FILE. WRITE OUT3.
00057          000DB 000336 P1. READ ERROR-FILE INTO OUT3 AT END GO TO GET-FIRST-INPUT.
00058          000E7 000337 WRITE OUT3. GO TO P1.
00059          000340 GET-FIRST-INPUT.
00060          000ED 000350 READ INPUT-DEVICE AT END GO TO CLOSE-INITIAL-INPUT.
00061          000360 WRITE OUT1 FROM INPUT.
**** 269 **** IDENTIFIER MISSING AFTER 'FROM'
00062          000F2 000370 GO TO GET-FIRST-INPUT.
00063          000380 CLOSE-INITIAL-INPUT.
00064          000F3 000390 CLOSE INPUT-DEVICE, OUTPUTONE.
00065          000F9 000400 OPEN INPUT OUTPUTONE.
00066          000410 GET-SECOND-INPUT.
00067          000FF 000420 READ OUTPUTONE AT END GO TO CLOSE-SECOND-INPUT.

```

Figure 3. Sample Source Program and Procedure Division Map Listing

```

00068      00104  000430  WRITE OUT2 FROM OUT1.
00069      0010C  000440  GO TO GET-SECOND-INPUT.
00070      000450  CLOSE-SECOND-INPUT.
00071      0010D  000480  CLOSE OUTPUTONE, AND OUTPUTTWO.
**** 049 **** SYNTACTICAL ERROR
00072      00110  000490  OPEN INPUT OUTPUTONE, OUTPUTTWO.
00073      000500  COMPARE-RECORDS.
00074      0011C  000510  READ OUTPUTONE      AT END GO TO TERMINAT.
**** 234 **** UNDEFINED PROCEDURE NAME - EXTERNAL REFERENCE GENERATED
00075      00121  000520  READ OUTPUTTWO     AT END GO TO ERR.
00076      00126  000530  IF OUT1 = OUT2 GO TO COMPARE-RECORDS.
00077      0012B  000540  MOVE ' RECORD MISMATCH ' TO OUT3.
00078      00132  000550  WRITE OUT3.
00079      00137  000560  WRITE OUT3 FROM OUT1.
00080      0013F  000570  WRITE OUT3 FROM OUT2.
00081      000580  GOTO COMPARE-RECORDS.
**** 049 **** SYNTACTICAL ERROR
00082      000590  ERR.
00083      00147  000600  MOVE ' PREMATURE EOF ON DEVICE-2 ' TO OUT3.
00084      0014E  000610  WRITE OUT3.
00085      000620  TERMINATE.
**** 049 **** SYNTACTICAL ERROR
**** 003 **** AREA A VIOLATION
00086      00153  000460  MOVE ' END SEQUENTIAL IO TEST ' TO OUT3.
00087      0015A  000470  WRITE OUT3.
00088      0015F  000630  CLOSE OUTPUTONE, OUTPUTTWO, OUTPUTTHREE.
**** 159 **** EXTERNAL REFERENCE GENERATED

*** NUMBER OF DIAGNOSTIC MESSAGES  12 ***   HIGHEST SEVERITY LEVEL  7 ***

```

Figure 3. Sample Source Program and Procedure Division Map Listing (cont.)

MAIN (Main Program)

Two or more source programs can be compiled separately and their object modules combined to form a single executable program. The MAIN option specifies that the source program to be compiled is the main program; its inclusion on the COBOL processor control command is for commentary purposes only.

MAPS (Both Data Division Map and Procedure Division Map)

This option specifies that both the Data Division Map and the Procedure Division Map are to be produced.

PMAP (Procedure Division Map)

This option specifies that the Procedure Division Map is to be produced. This Map appears as part of the Source Program listing. The relative starting location of each sentence in the PROCEDURE DIVISION is listed following the associated source line number. Figure 3 illustrates a sample source program and Procedure Division Map listing.

SEG (Priority Segments)

This option specifies that the source program to be compiled is a segmented program, i.e., it contains Priority Segments. This option must be specified if a segmented object program is desired; otherwise, a nonsegmented object program is produced.

SEQCHK (Sequence Check)

This option specifies that the sequence number field (columns 1 through 6) of the source program lines is tested for ascending sequence. If an out-of-sequence condition occurs, the compiler issues the diagnostic "SOURCE PROGRAM OUT OF SEQUENCE".

SO (Source Output)

This option allows the user to write his source program out to a keyed file. The keys used are compatible with the Edit processor. When using this option, an ASSIGN control command for the system DCB M:SO must be provided.

SRTx (Co-Resident Sort)

This option specifies that the SORT verb will be compiled with the co-resident sort code and a tree structure generated by the compiler. The proper element files must be loaded at load time to ensure execution of this code. The COBOL object program and the Sort processor will be loaded together to form one load module, thus eliminating the need for the COBOL program to be swapped in and out. (Refer to "Co-Resident Sort Feature" in Chapter 5.) The x can be either an S or an R, indicating that the programmer desires the sequential (tape, mixed tape/disk) or the Random (disk only) sorting technique to be used.

SUB (Subprogram)

This option specifies that the source program to be compiled is a subprogram. No "END start" address will be generated by the compiler.

SYN (Syntax Checking)

This option provides only for syntactical checking of the COBOL source program; code generation is bypassed, thereby saving machine time. It is recommended that this option be used for preliminary compilations, as most of the errors in the source program are detected during this pass. For the final compilation (i.e., with the SYN option deleted), remaining errors are detected during code generation.

TEST (On-Line Debugger)

This option specifies that the compiled program is to be tested using the on-line debugger. It causes the computer to create all necessary files and linkages for the on-line debugger.

XREF (Cross-Reference Listing)

This option specifies that a cross-reference listing of the COBOL source program is to be produced on the LO device. All nonreserved words defined in the source program are listed in alphanumeric order. Shown to the left of each word is the source line number of the statement where the word is initially defined. To the right, overflowning if need be to lines following, are the line numbers of statements in which references are made to the words. Figure 4 shows a sample cross-reference listing.

COBOL CROSS-REFERENCE LISTING		21:43 MAR 12, 1975 PAGE 1				
EXTERNAL	C:ERR	00088				
00052	CHECK-USE-VERB-FORMAT-2					
00063	CLOSE-INITIAL-INPUT	00060				
00070	CLOSE-SECOND-INPUT	00067				
00073	COMPARE-RECORDS	00076				
00032.00002	DATA-0	00040				
00032.00003	DATA-1	00040	00042	00043	00056	
00034	DATA-2	00040	00042	00043		
00032	DATUM					
00082	ERR	00075				
00030	ERROR-FILE	00037	00049	00055	00056	00057
00031	ERROR-REC	00030	00038	00054	00055	
00059	GET-FIRST-INPUT	00057	00062			
00066	GET-SECOND-INPUT	00069				
00021	INP	00020				
00020	INPUT-DEVICE	00047	00060	00064		
00028	OP-FILE					
00029	OP-REC	00028				
00026	OUTPUTTHREE	00049	00088			
00022	OUTPUTONE	00048	00064	00065	00067	00071
		00072	00074	00088		
00024	OUTPUTTWO	00048	00072	00075	00088	
00023	OUT1	00022	00068	00076	00079	
00025	OUT2	00024	00068	00076	00080	
00027	OUT3	00026	00043	00050	00051	00053
		00056	00057	00058	00077	00078
		00079	00080	00083	00084	00086
		00087				

Figure 4. Sample Cross-Reference Listing

3. INTER-PROGRAM COMMUNICATION

Introduction

Any given COBOL source program may be subdivided into two or more parts, each of which can be compiled independently. One of these subdivisions must be designated as the main or calling program at both compilation and execution times. The remaining subdivisions are designated as subprograms or called programs. Each subdivision of the total program, whether the calling program or a called program, has the format of a complete COBOL source program. Each subdivision must contain IDENTIFICATION, ENVIRONMENT, DATA, and PROCEDURE DIVISIONs.

Rules for Usage

Successful usage of the feature requires observance of two alternative sets of rules. The first set is somewhat restrictive, but requires a minimal knowledge of the contents of the calling program and its subprograms and thus is less susceptible to programmer error.

1. The ENVIRONMENT DIVISIONs must all be complete with regard to the total program, and should be identical.
2. The FILE SECTIONs and REPORT SECTIONs must all be complete with regard to the total program, and should be identical.
3. If the programmer wishes to have data referenced by both the main and subprograms he can do it in one of two ways:
 - a. Provide a LINKAGE SECTION and a PROCEDURE DIVISION USING statement in the called program and a CALL statement in the calling program. The LINKAGE SECTION will reference WORKING STORAGE items in the main program.
 - b. Provide an identical COMMON-STORAGE SECTION in both the main and subprograms. Items in COMMON-STORAGE can then be referred to by both programs and can also be used as parameters in the ENTER statement when calling a Metasymbol or FORTRAN subprogram.

See the Xerox ANS COBOL/LN Reference Manual, 90 15 00, Chapter 10, for more detailed information on this subject.

4. The PROCEDURE DIVISION of the calling program must contain all DECLARATIVES sections desired in the total program.

The second set of rules requires a careful and detailed analysis of the individual source programs but permit omission of repetitious entries, thus reducing the size of the programs and improving compilation time.

1. ENVIRONMENT DIVISION

a. Calling Program

The complete ENVIRONMENT DIVISION for the total program must be written.

b. Subprograms

Each subprogram must contain SELECT sentences only for those files referenced in its PROCEDURE DIVISION (and described in its DATA DIVISION).

2. DATA DIVISION

a. FILE SECTION

(1) Calling Program

The file and record descriptions for all files in the total program must be included.

(2) Subprograms

The file and record descriptions for all files referenced in the PROCEDURE DIVISION (and mentioned in an ENVIRONMENT DIVISION SELECT sentence) must be included.

b. REPORT SECTION

(1) Calling Program

The report descriptions of all reports used in the total program must appear.

(2) Subprograms

Each subprogram must contain only the descriptions of reports actually referenced therein. (The file description of the file containing the associated REPORT IS clause must also be present.)

Memory space is allocated and Data Control Blocks generated for the files described in the FILE SECTION of the main program. All subprograms making reference to reports or report data, when incorporated into the total program at run-time, refer to the areas reserved by the main program. Similarly, memory space is assigned in accordance with the COMMON-STORAGE SECTION description in the main program, and this area is shared by the main program and all associated subprograms when combined at run-time. The main program and each subprogram may have its own WORKING-STORAGE SECTION; data described therein is not shared, but is private to the program in which it is defined. However, WORKING-STORAGE items in a main program may be referred to in a subprogram by the use of a LINKAGE SECTION in the subprogram and the PROCEDURE DIVISION USING statement as mentioned previously in paragraph 3a above.

Program control can flow naturally between independent compilations employing the normal COBOL verbs GO TO and PERFORM. Only one additional statement is introduced into the Xerox ANS COBOL language to provide this natural flow. Any procedure point to which control may be passed by a separately compiled program must be declared as an external definition. The ENTER COBOL statement names those entry points (section- and paragraph-names) within the program that are to be visible to sequence control statements in other compilations.

4. OBJECT PROGRAM

The object program produced by the COBOL compiler is in Xerox standard object language format. It is output via the M:BO and/or M:GO system Data Control Blocks (DCBs) as directed by the options expressed in the COBOL control command. The compiler assumes either that the appropriate DCB has been pre-conditioned by ASSIGN commands to reflect the media on which the object program is to appear and the file-name(s) under which the object module is to be cataloged, or that those options have been deliberately permitted to default to the standard system conditions.

Segmented Object Programs

A single COBOL source program can be so large that its object-time storage requirements exceed available computer memory. When such a situation occurs, the program may be partitioned into logical blocks called "overlays" or, in COBOL terminology, "Priority Segments". The logical structure of a program segmented in this manner resembles a simple tree. COBOL object programs employ the branch reference loading mode: each overlay is loaded into core storage when control reaches a reference to it during execution of the root or another overlay segment of the program. The SEG option must be specified as a COBOL control command option in order to produce a segmented program.

During compilation of a segmented program, only the root segment module is output via the M:BO and/or M:GO DCBs under the file-name contained in the DCB. It is possible to create permanent relocatable object modules (ROMs) by assigning the M:BO DCB to a file. The root and each overlay will then be output as permanent ROMs, as described below. Since the computer uses the M:LI DCB to write out the overlay segments for the GO file, the M:LI assignment should not be protected with a password. If it is, the user cannot access the overlays.

Overlay segment modules are output in individual files on disk; they are identified by the root segment module name with a two-digit suffix. For example, if the root segment name is OBJPROG, overlay segments are named OBJPROG01, OBJPROG02, OBJPROG03, and so on. In addition, the tree structure is specified in a TREE control command image, which is output on disk in a file that is also identified by the root segment module name with two zeros added, e.g., OBJPROG00. No tree structure is created for the BO output.

The TREE control command may be punched out by the PCL control command

```
COPY DC/OBJPROG00 TO CP
```

Similarly, each overlay segment module may be punched by the control command

```
COPY DC/OBJPROGnn TO CP(BIN)
```

where nn is the two-digit identifier for the segment, as explained above. (See "Segmentation Feature" in Chapter 3.)

Object Program Structure

The object program is produced in one or more modules: one module comprises the entire program except for priority segments; one additional module is created for each priority-number used between the specified SEGMENT-LIMIT (or 50) and 99. A priority segment (overlay) module consists of a single (standard) control section and contains only the procedure code and literals of the relevant PROCEDURE DIVISION sections. The root segment module comprises multiple control sections. Figure 5 illustrates arrangement of the standard control section of the root segment module.

The root segment module may also contain a number of dummy program sections, which are created in the following instances:

1. **COMMON-STORAGE SECTION.** The COMMON-STORAGE SECTION of the DATA DIVISION of the source program is represented in the object program by a dummy program section whose name is supplied by the CS(name) control command option. If the CS(name) option is not specified, the name TALLY is used. The Special Register TALLY is generated as the initial entry in the COMMON-STORAGE dummy section produced by each COBOL compilation.
2. **DCBs.** A DCB (Data Control Block) appears in the object program for each file declared in the source program by a File Description (FD) file-name entry in the FILE SECTION of the DATA DIVISION, and is output as a dummy program section named F:file-name.

3. File Record Areas. A record area the size of the largest record defined is reserved for each file declared by an FD entry, and is represented in the object program by a dummy program section named file-name.
4. File Index Areas. Each file declared in the source program has associated with it one additional dummy program section named I:file-name, wherein five words are assigned for file control purposes. One additional word is allocated for each index-name mentioned in INDEXED BY options of the OCCURS clause in record descriptions pertaining to the file.
5. Report Table Area. Each report declared by a Record Description (RD) report-name entry in the REPORT SECTION of the DATA DIVISION of the source program is described in the object program by a table that is produced as a dummy program section named R:report-name.
6. Report Storage Area. The print lines, accumulators, control fields, and other data storage associated with each report are represented in the object program by a dummy program section named report-name.
7. WORKING-STORAGE SECTION. The WORKING-STORAGE SECTION in the DATA DIVISION has a definition (DEF) associated with it that indicates its beginning location. This definition is labeled DEF\$WK.

These dummy program sections are illustrated by the load module map in Figure 6. Circled numbers are keyed to the itemized discussion above. Note that the map does not correlate with the sample object listing shown in Figure 2.

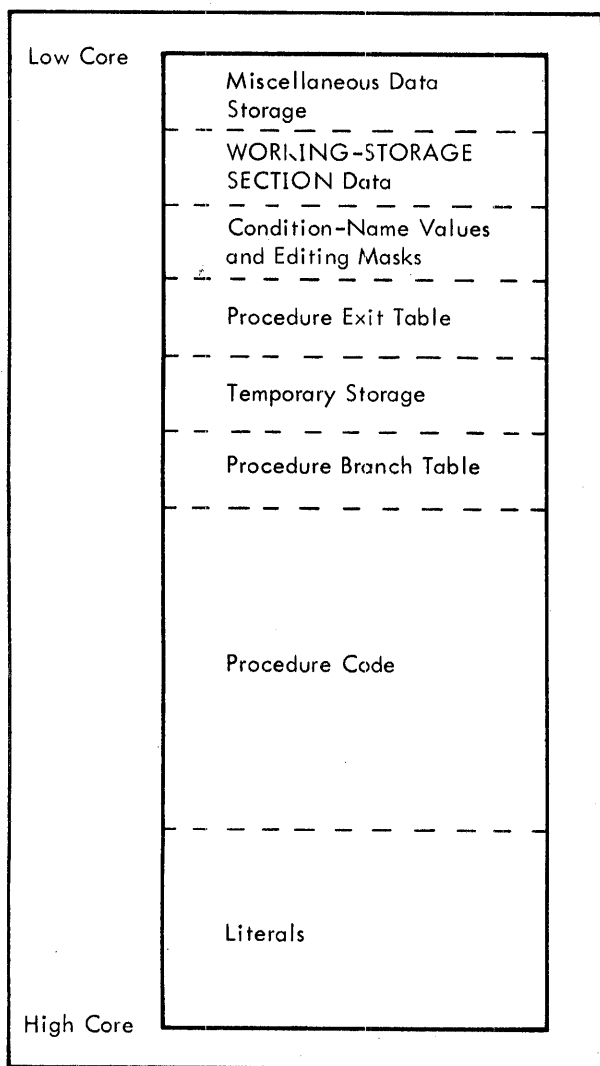

DSEC	C302	0	TALLY	1
DSEC	C304	0	INXFILE	3
DSEC	C318	0	I:INXFILE	4
DSEC	9016	0	F:INXFILE	2
DSEC	C320	0	I:REPXFILE	
DSEC	9048	0	F:REPXFILE	
DSEC	C328	0	PRINTXFILE	
DSEC	C346	0	I:PRINTXFILE	
DSEC	909C	0	F:PRINTXFILE	
DSEC	C34E	0	USAGE-REPORT	6
DSEC	C53E	0	R:USAGE-REPORT	5
UDEF	COB6	0	DEF\$WK	7
UDEF	C064	0	BTG	
CSEC	C064	0		
LIB	8C3C	0	M:UC	
LIB	8CF6	0	M:XX	
LDCB	90F0	0	M:DO	
LIB	C814	0	C:ERA	
LIB	C814	0	C:ABA	
LIB	CB01	0	C:RRK	
LIB	CCC8	0	C:TRP	
LIB	CB40	0	C:RRT	
LIB	CB42	0	C:RRS	
LIB	CB44	0	C:RRR	
LIB	CB6E	0	C:RRQ	
LIB	CB63	0	C:RRE	
LIB	CBFD	0	C:RRC	
LIB	CA17	0	C:CDB	
LIB	CBF5	0	C:RRA	
LIB	CB8A	0	C:RRJ	
LIB	CBF9	0	C:RRB	
LIB	CB79	0	C:RRF	
LIB	CB51	0	C:RRD	
LIB	C666	0	C:OPN	
LIB	C73D	0	C:RLR	

Figure 5. Standard Control Section of a Root Segment Module

Figure 6. Load Module Map

5. PROGRAM COMPILATION AND EXECUTION

Compilation of Large Source Programs

It is recommended that the following two monitor control commands be used for compilation of large source programs.

1. LIMIT control command

Compilation of large source programs requires a large amount of temporary disk storage. For this reason the TSTORE option should be specified to allow the use of additional available disk storage.

Example: !LIMIT (TSTORE,2000)

Also, temporary disk storage can be conserved by specifying that the compiler copy of the source program (from which the source listing is built) be saved on magnetic tape rather than on disk. The following control command permits this alternative assignment:

```
!ASSIGN F:W7,(LABEL,name),(SN,value),(OUTIN)
```

where

name specifies the name of the file.

value specifies the serial number of the tape reel to be used.

2. POOL control command

Compilation speed can be improved significantly by specifying additional buffers for use by the monitor.

Example: !POOL (FPOOL,8),(IPOOL,8)

Examples of both the LIMIT and POOL control commands are presented in the deck setup in Figure 8.

COBOL Work Files

The COBOL compiler uses 11 work files having the DCB names F:W0 through F:W10. To avoid confusion, the COBOL source program should not use those DCB names. In any event, it is good practice to place the !ASSIGN cards for user files after the !COBOL card and source deck, as illustrated throughout this manual.

COBOL Library on Tape

Normally, library files are stored on disk. It is possible, however, to have library files on labeled tape. In this case, an ASSIGN control command for M:LI must be specified. For example,

```
!ASSIGN M:LI,(LABEL,name,account),(SN,value)
```

where

name specifies the name of a labeled file.

account specifies the account under which the tape was created.

value specifies the serial number of the tape reel to be used.

Print File Handling

If the BEFORE and/or AFTER ADVANCING clause is used in a COBOL source program, the data control block must indicate that the first position of the record is to be treated as a vertical-format-control character. If the file was assigned to the printer in the COBOL source program, the DCB will be pre-set with the VFC option. This eliminates the need for an ASSIGN control command.

If the ADVANCING option is not specified in a WRITE instruction addressed to a print file, the user is assumed to have indicated the vertical-format-control character at the source program level and stored this character in the first byte of the record to be printed. The action indicated by the control character is performed, and then the record is printed. The codes controlling the vertical format on the Xerox Buffered Line Printers, Models 7440/7445 and 7446, are shown in Table 1.

Table 1. Xerox Buffered Line Printers, Models 7440/7445 and 7446, Vertical-Format Control Codes

Code (Hexadecimal)	Meaning
40	Print, single space.
60	Print, inhibit automatic upspace after printing.
C0	Print, single space (same as 40).
C1	Single space, print, single space.
C2	Space 2 lines, print, single space.
C3	Space 3 lines, print, single space.
:	:
CF	Space 15 lines, print, single space.
D0 [†]	Skip to channel 0 (bottom of page), print, inhibit automatic upspace.
D1 [†]	Skip to channel 1 (top of page), print, inhibit automatic upspace.
D2 [†]	Skip to channel 2, print, inhibit automatic upspace.
D3 [†]	Skip to channel 3, print, inhibit automatic upspace.
:	:
D7 [†]	Skip to channel 7, print, inhibit automatic upspace.
E0	Print, inhibit automatic upspace after printing (same as 60).
E1 [†]	Space 1 line, print, inhibit automatic upspace after printing.
E2 [†]	Space 2 lines, print, inhibit automatic upspace after printing.
:	:
EF [†]	Space 15 lines, print, inhibit automatic upspace after printing.
F0	Skip to channel 0 (bottom of page), print, single space.
F1	Skip to channel 1 (top of page), print, single space.
F2	Skip to channel 2, print, single space.
:	:
F7	Skip to channel 7, print, single space.

[†]Model 7446 only.

Deck Structures

Basic Setups

Figures 7, 8, and 9 show some of the ways in which COBOL program decks may be prepared for COBOL compilation and execution.

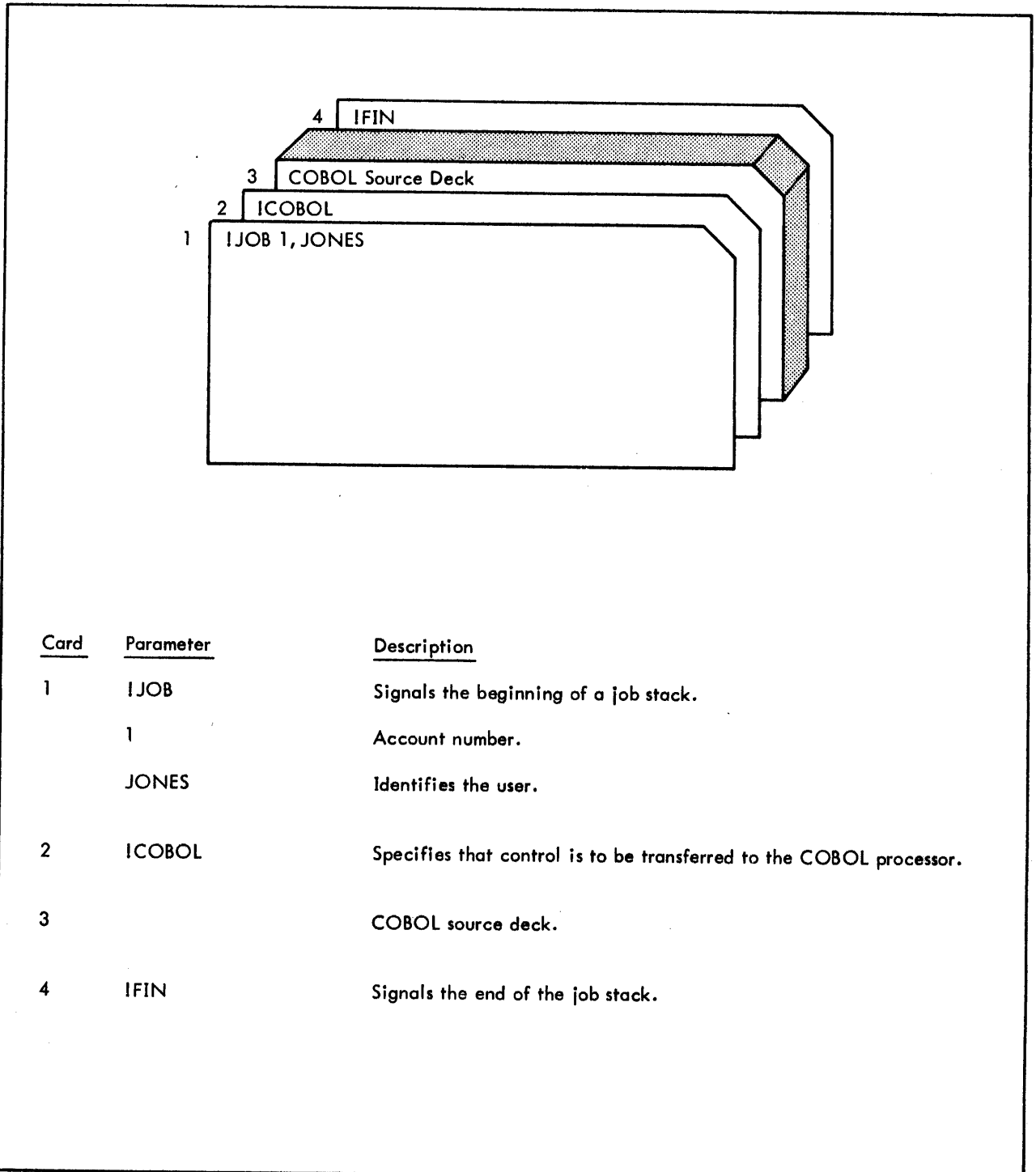
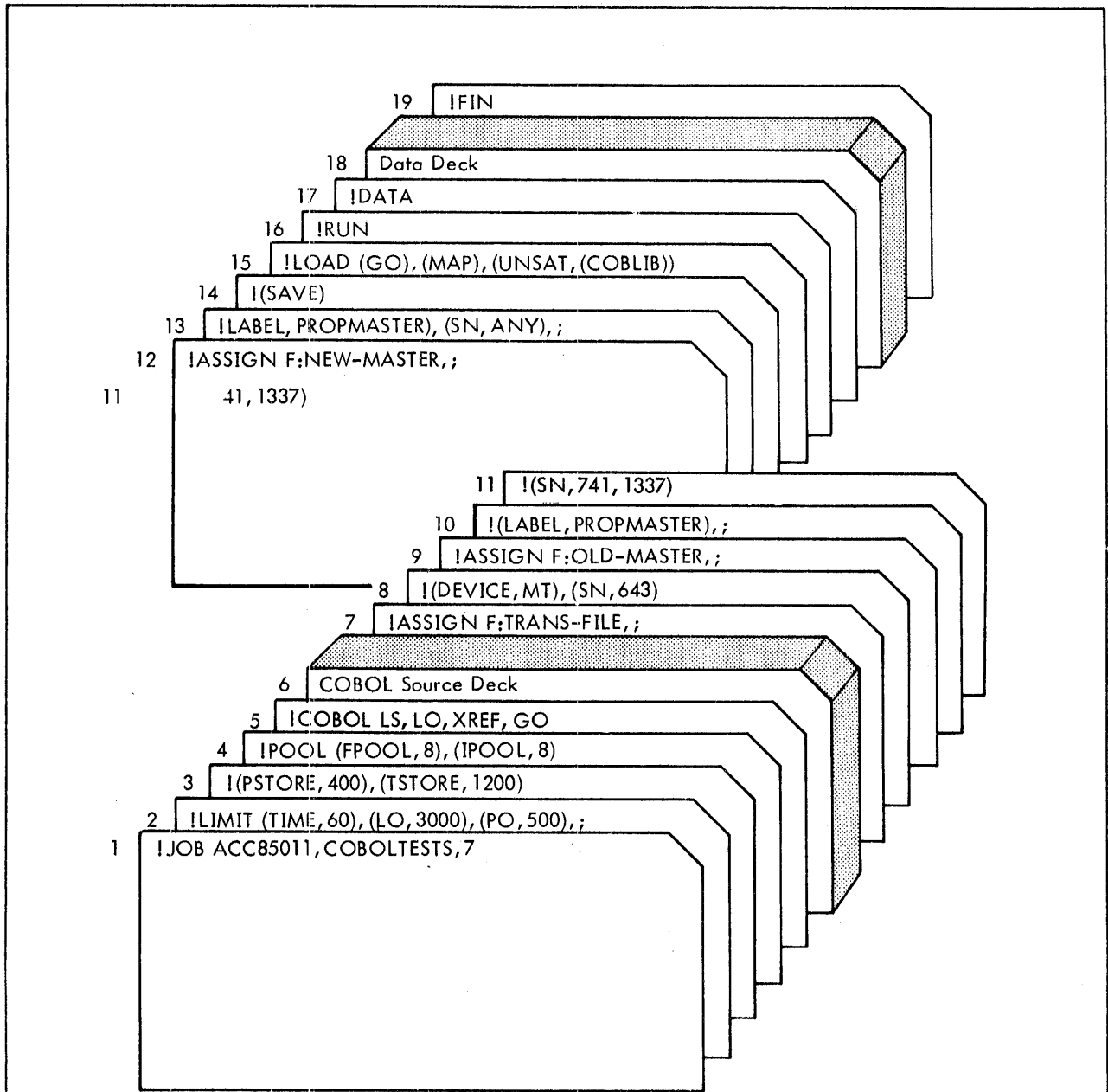

Figure 7. Basic Setup – Compilation Only



<u>Card</u>	<u>Parameter</u>	<u>Description</u>
1	IJOB ACC85011 COBOLTESTS 7	Signals the beginning of a job stack. Account number. Identifies the user. Indicates job priority.
2	!LIMIT (TIME, 60)	Control command that specifies the maximum values for various system resources used by the job. Specifies limit of 60 minutes execution time.

Figure 8. Basic Setup – Compilation and Execution

<u>Card</u>	<u>Parameter</u>	<u>Description</u>
	(LO,3000)	Specifies limit of 3000 pages listing output.
	(PO,500)	Specifies limit of 500 cards punch output.
	;	Signals that this LIMIT command is continued on the following card.
3	I(PSTORE,400)	Specifies limit of 400 granules permanent disk storage. (This card is part of the preceding LIMIT command.)
	(TSTORE,1200)	Specifies limit of 1200 granules temporary disk storage.
4	IPOOL	Control command that specifies additional buffers for use by the monitor.
	(FPOOL,8)	Specifies that 8 buffers are to be assigned to file management use.
	(IPOOL,8)	Specifies that 8 buffers are to be assigned to the file index pool.
5	ICOBOL	Control command that specifies control is to be transferred to the COBOL processor.
	LS	Specifies that the source program is to be listed.
	LO	Specifies that the object program is to be listed.
	XREF	Specifies that the cross-reference listing is to be produced.
	GO	Specifies that the program is to be executed after compilation.
6		COBOL source deck.
7	IASSIGN	Control command that specifies the file and physical peripheral device to be used.
	F:TRANS-FILE	DCB name of TRANS-FILE file.
	;	Signals that this ASSIGN command is continued on the following card.
8	I(DEVICE,MT)	Specifies that the file is to be assigned to a magnetic tape unit. (This card is part of the preceding ASSIGN command.)
	(SN,643)	Specifies that the input file is contained on reel number 643.

Figure 8. Basic Setup – Compilation and Execution (cont.)

<u>Card</u>	<u>Parameter</u>	<u>Description</u>
9	!ASSIGN	Control command that specifies the file and physical peripheral device to be used.
	F:OLD-MASTER	DCB name of OLD-MASTER file.
	;	Signals that this ASSIGN command is continued on the following card.
10	!(LABEL,PROPMASTER)	Specifies that the file is named PROPMASTER. (This card is part of the preceding ASSIGN command.)
	;	Signals that this ASSIGN command is continued on the following card.
11	!(SN,741,1337)	Specifies that the input file is contained on two reels, numbers 741 and 1337. (This card is part of the preceding ASSIGN command.)
12	!ASSIGN	Control command that specifies the file and physical peripheral device to be used.
	F:NEW-MASTER	DCB name of NEW-MASTER file.
	;	Signals that this ASSIGN command is continued on the following card.
13	!(LABEL,PROPMASTER)	Specifies that the output file is to be named PROPMASTER. (This card is part of the preceding ASSIGN command.)
	(SN,ANY)	Specifies that the output file is to be written on any available reel.
	;	Signals that this ASSIGN command is continued on the following card.
14	!(SAVE)	Specifies that the file is to be saved. (This card is part of the preceding ASSIGN command.)
15	!LOAD	Control command that directs the resident loader to form a relocatable load module.
	(GO)	Specifies that data from the user temporary GO file is to be included in the root of the load module.
	(MAP)	Specifies that all external references and definitions for the load module are to be listed.
	(UNSAT,(COBLIB))	Specifies that the COBOL library (identified by account number COBLIB) is to be searched for external definitions required for the load module.

Figure 8. Basic Setup – Compilation and Execution (cont.)

<u>Card</u>	<u>Parameter</u>	<u>Description</u>
16	IRUN	Control command that specifies the program is to be executed.
17	!DATA	Control command that specifies a data deck is to follow.
18		Data deck.
19	IFIN	Signals the end of the job stack.

Figure 8. Basic Setup – Compilation and Execution (cont.)

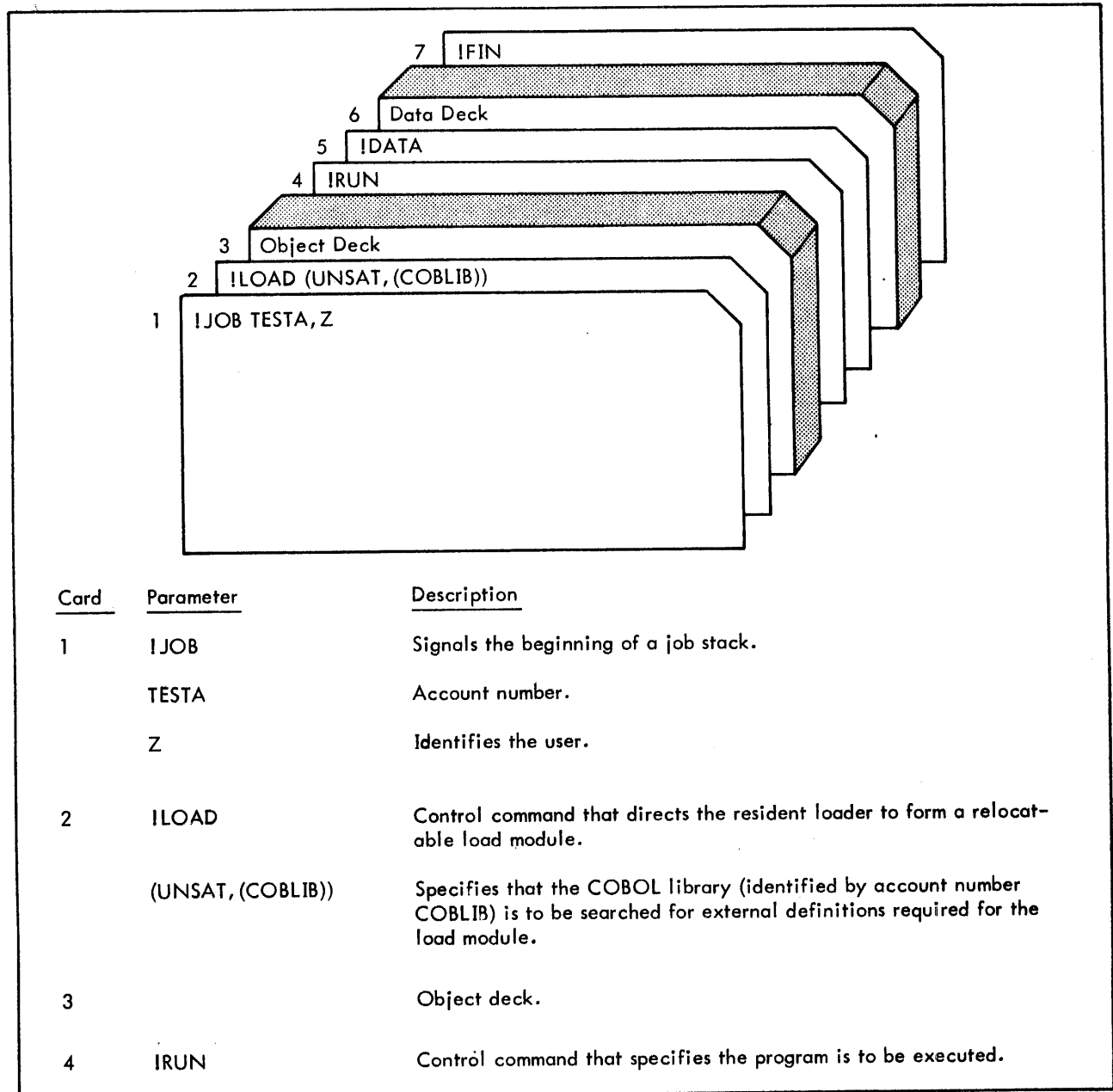

Figure 9. Basic Setup – Execution with Object Deck

<u>Card</u>	<u>Parameter</u>	<u>Description</u>
5	IDATA	Control command that specifies a data deck is to follow.
6		Data deck.
7	IFIN	Signals the end of the job stack.

Figure 9. Basic Setup – Execution with Object Deck (cont.)

Segmentation Feature

To combine segmented programs into a single executable program, the desired overlay structure must be communicated to the loader. This may be done in the usual way by a TREE control command or semiautomatically by a PTREE command, which references the files containing the TREE commands generated by individual compilations. Refer to "Segmented Object Programs" in Chapter 2.

Figures 10, 11, and 12 show how a COBOL program with priority segments is set up for compilation and execution.

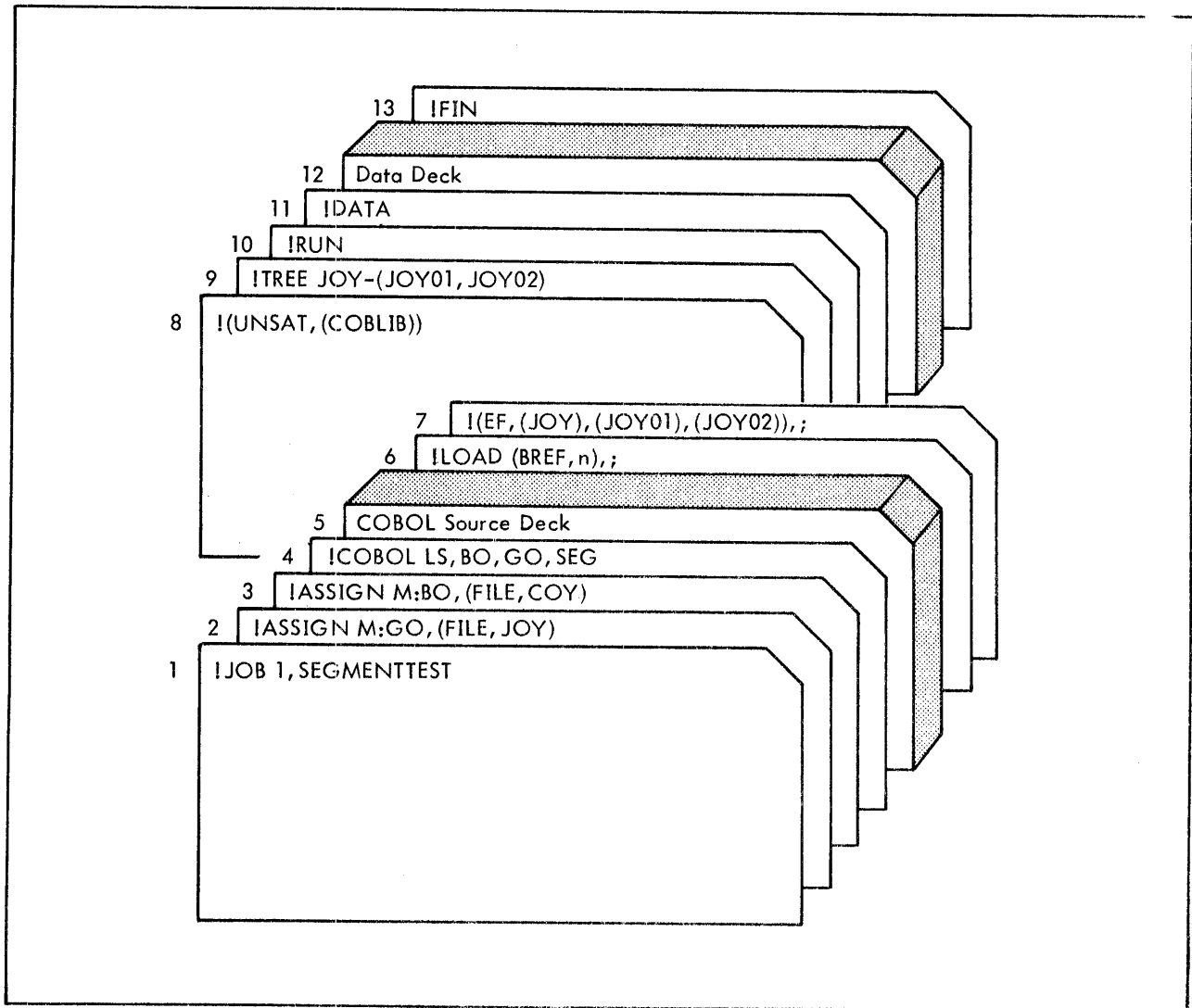

Figure 10. Segmentation Feature – Compilation and Execution

<u>Card</u>	<u>Parameter</u>	<u>Description</u>
1	IJOB	Signals the beginning of a job stack.
	1	Account number.
	SEGMENTTEST	Identifies the user.
2	IASSIGN	Control command that specifies the file and physical peripheral device to be used.
	M:GO	The file is the system GO file.
	(FILE, JOY)	Specifies that the file is to be a disk file named JOY.
3	IASSIGN	Control command that specifies the file and physical peripheral device to be used.
	M:BO	The file is the system BO file.
	(FILE, COY)	Specifies the file is to be a disk file named COY.
4	!COBOL	Control command that specifies control is to be transferred to the COBOL processor.
	LS	Specifies that the source program is to be listed.
	BO	Specifies that permanent relocatable object modules are to be produced.
	GO	Specifies that the program is to be executed after compilation.
	SEG	Specifies that the program contains priority segments.
5		COBOL source deck.
6	ILOAD	Control command that directs the resident loader to form a relocatable load module.
	(BREF, n)	Specifies that the overlay structure is to be set up for the branch referencing loading mode. The parameter "n" (if present) is a decimal value specifying the maximum number of interbranch references within the program. If "n" is absent or zero, a total of 11 words per segment are reserved in the reference loading table (two words per reference).
	;	Signals that this LOAD command is continued on the following card.
7	I(EF, (JOY), (JOY01), (JOY02))	Specifies that the modules of the root segment (JOY) and the two overlay segments (JOY01 and JOY02) are to be included in the load module. (This card is part of the preceding LOAD command.)
	;	Signals that the LOAD command is continued on the following card.

Figure 10. Segmentation Feature – Compilation and Execution (cont.)

Card	Parameter	Description
8	I(UNSAT,(COBLIB))	Specifies that the COBOL library (identified by account number COBLIB) is to be searched for external definitions required for the load module. (This card is part of the preceding LOAD command.)
9	ITREE JOY-(JOY01,JOY02)	Control command that specifies the overlay structure of the load module. Specifies that module JOY is the root segment and modules JOY01 and JOY02 are overlay segments.
10	IRUN	Control command that specifies the program is to be executed.
11	IDATA	Control command that specifies a data deck is to follow.
12		Data deck.
13	IFIN	Signals the end of the job stack.

Figure 10. Segmentation Feature – Compilation and Execution (cont.)

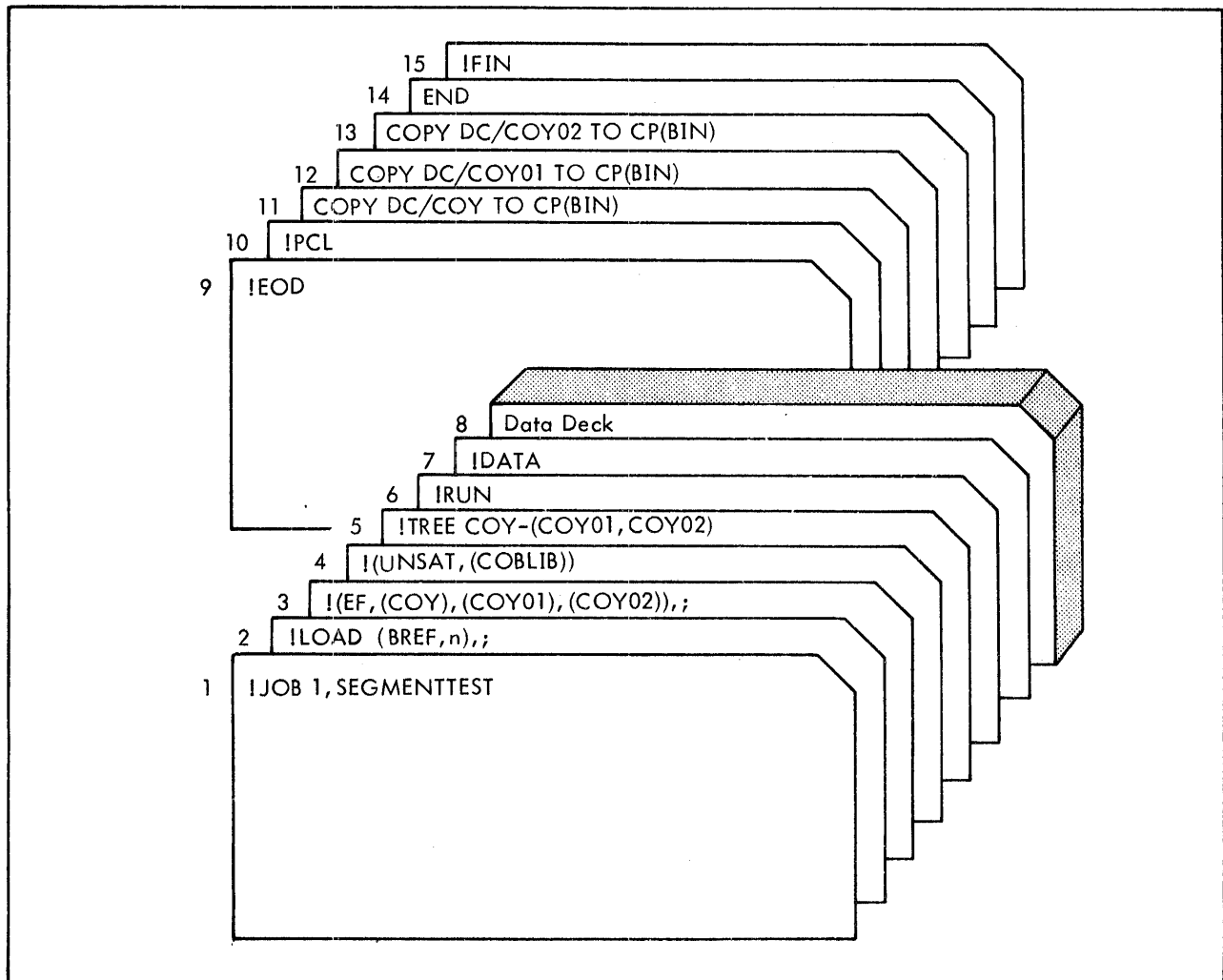

Figure 11. Segmentation Feature – Load from BO File, Execute, and Punch BO File

<u>Card</u>	<u>Parameter</u>	<u>Description</u>
1	IJOB	Signals the beginning of a job stack.
	1	Account number.
	SEGMENTTEST	Identifies the user.
2	ILOAD	Control command that directs the resident loader to form a relocatable load module.
	(BREF, n)	Specifies that the overlay structure is to be set up for the branch referencing loading mode. The parameter "n" (if present) is a decimal value specifying the maximum number of interbranch references within the program. If "n" is absent or zero, a total of 11 words per segment are reserved in the reference loading table (two words per reference).
	;	Signals that this LOAD command is continued on the following card.
3	I(EF, (COY), (COY01), (COY02))	Specifies that the modules of the root segment (COY) and the two overlay segments (COY01 and COY02) are to be included in the load module. (This card is part of the preceding LOAD command.)
	;	Signals that the LOAD command is continued on the following card.
4	I(UNSAT, (COBLIB))	Specifies that the COBOL library (identified by account number COBLIB) is to be searched for external definitions required for the load module. (This card is part of the preceding LOAD command.)
5	ITREE	Control command that specifies the overlay structure of the load module.
	COY-(COY01, COY02)	Specifies that module COY is the root segment and modules COY01 and COY02 are overlay segments.
6	IRUN	Control command that specifies the program is to be executed.
7	IDATA	Control command that specifies a data deck is to follow.
8		Data deck.
9	IEOD	Defines the end of the data deck.
10	IPCL	Initiates the Peripheral Conversion Language (PCL) processor.
11	COPY DC/COY TO CP(BIN)	Punches a binary deck for root COY.

Figure 11. Segmentation Feature – Load from BO File, Execute, and Punch BO File (cont.)

Card	Parameter	Description
12	COPY DC/COY01 TO CP(BIN)	Punches a binary deck for first overlay segment.
13	COPY DC/COY02 TO CP(BIN)	Punches a binary deck for second overlay segment.
14	END	Terminates PCL operations.
15	!FIN	Signals the end of the job stack.

Figure 11. Segmentation Feature – Load from BO File, Execute, and Punch BO File (cont.)

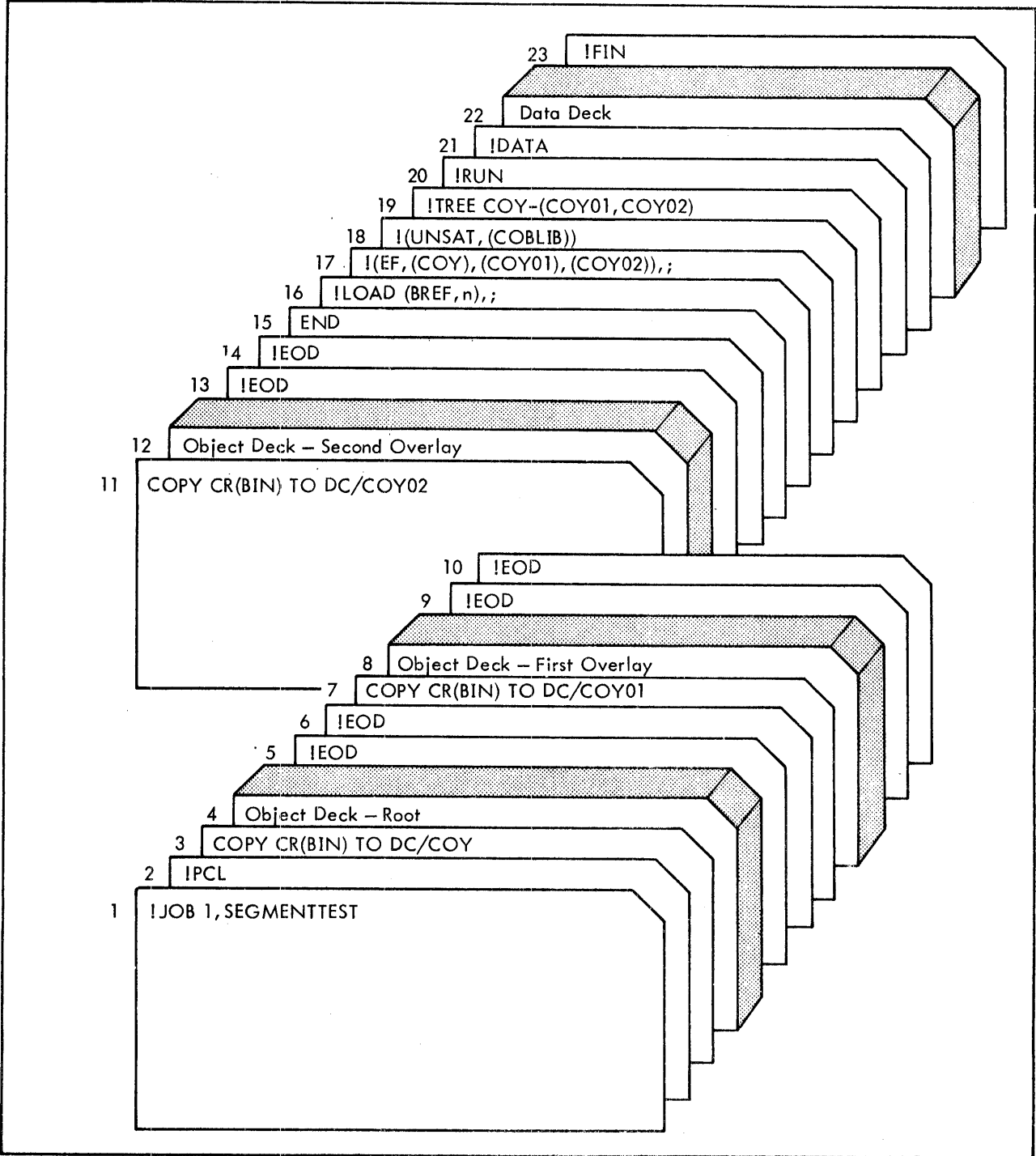

Figure 12. Segmentation Feature – Execution from Object Decks

<u>Card</u>	<u>Parameter</u>	<u>Description</u>
1	IJOB	Signals the beginning of a job stack.
	1	Account number.
	SEGMENTTEST	Identifies the user.
2	IPCL	Initiates the Peripheral Conversion Language (PCL) processor.
3	COPY CR(BIN) TO DC/COY	Copies object deck from card reader to disk file named COY.
4		Object deck for root segment.
5	IEOD	} Signals PCL of the end of the root segment card deck.
6	IEOD	
7	COPY CR(BIN) TO DC/COY01	Copies object deck from card reader to disk file named COY01.
8		Object deck for first overlay segment.
9	IEOD	} Signals PCL of the end of the overlay segment card deck.
10	IEOD	
11	COPY CR(BIN) TO DC/COY02	Copies object deck from card reader to disk file named COY02.
12		Object deck for second overlay segment.
13	IEOD	} Signals PCL of the end of the overlay segment card deck.
14	IEOD	
15	END	Terminates PCL operations.
16	ILOAD	Control command that directs the resident loader to form a relocatable load module.
	(BREF, n)	Specifies that the overlay structure is to be set up for the branch referencing loading module. The parameter "n"

Figure 12. Segmentation Feature – Execution from Object Decks (cont.)

<u>Card</u>	<u>Parameter</u>	<u>Description</u>
	(BREF,n) -(cont.)	(if present) is a decimal value specifying the maximum number of interbranch references within the program. If "n" is absent or zero, a total of 11 words per segment are reserved in the reference loading table (two words per reference).
	;	Signals that this LOAD command is continued on the following card.
17	!(EF,COY),(COY01),COY02))	Specifies that the modules of the root segment (COY) and the two overlay segments (COY01 and COY02) are to be included in the load module. (This card is part of the preceding LOAD command.)
	;	Signals that the LOAD command is continued on the following card.
18	!(UNSAT,(COBLIB))	Specifies that the COBOL library (identified by account number COBLIB) is to be searched for external definitions required for the load module. (This card is part of the preceding LOAD command.)
19	ITREE	Control command that specifies the overlay structure of the load module.
	COY-(COY01,COY02)	Specifies that module COY is the root segment and modules COY01 and COY02 are the overlay segments.
20	IRUN	Control command that specifies the program is to be executed.
21	IDATA	Control command that specifies a data deck is to follow.
22		Data deck.
23	IFIN	Signals the end of the job stack.

Figure 12. Segmentation Feature – Execution from Object Decks (cont.)

Inter-Program Communication (Subcompile Feature)

A single logical problem solution expressed in COBOL may be subdivided into two or more source programs that can be compiled separately and whose resultant object modules can be subsequently combined into a single executable program. Rules for such program subdivision are explained in Chapter 3. Briefly stated, one of the subdivisions must be designated as the main or calling program at both compilation and load times, and the remaining subdivisions must be denoted as subprograms or called programs (SUB option) at compilation time.

Figures 13, 14, 15, and 16 show how two COBOL programs are compiled separately and how the resultant object modules are then combined into a single executable program.

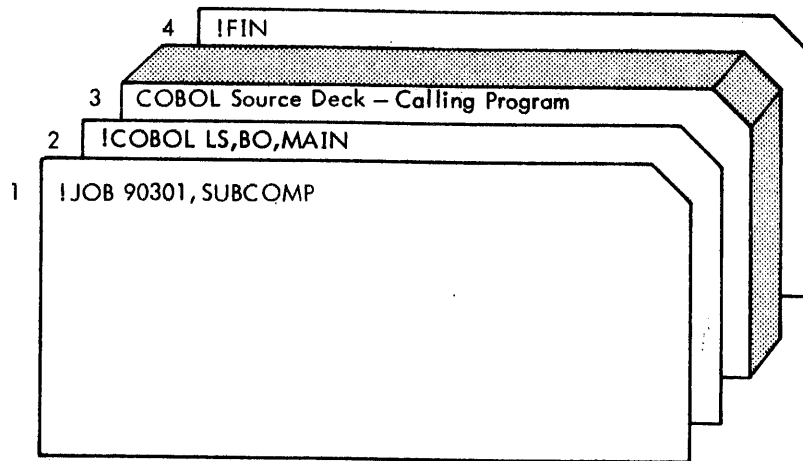

Card	Parameter	Description
1	IJOB	Signals the beginning of a job stack.
	90301	Account number.
	SUBCOMP	Identifies the user.
2	ICOBOL	Control command that specifies control is to be transferred to the COBOL processor.
	LS	Specifies that the source program is to be listed.
	BO	Specifies that the binary object deck is to be produced.
	MAIN	Specifies that this program is to be compiled as the main or calling program.
3		COBOL source deck of the main program.
4	IFIN	Signals the end of the job stack.

Figure 13. Inter-Program Communication – Compilation of Main or Calling Program

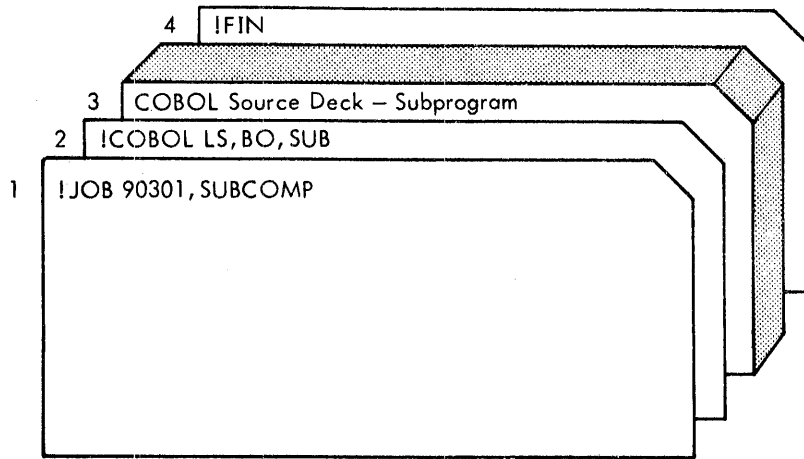

<u>Card</u>	<u>Parameter</u>	<u>Description</u>
1	IJOB	Signals the beginning of a job stack.
	90301	Account number.
	SUBCOMP	Identifies the user.
2	ICOBOL	Control command that specifies control is to be transferred to the COBOL processor.
	LS	Specifies that the source program is to be listed.
	BO	Specifies that the binary object deck is to be produced.
	SUB	Specifies that this program is to be compiled as the subprogram or called program.
3		COBOL source deck of the subprogram.
4	IFIN	Signals the end of the job stack.

Figure 14. Inter-Program Communication -- Compilation of Subprogram or Called Program

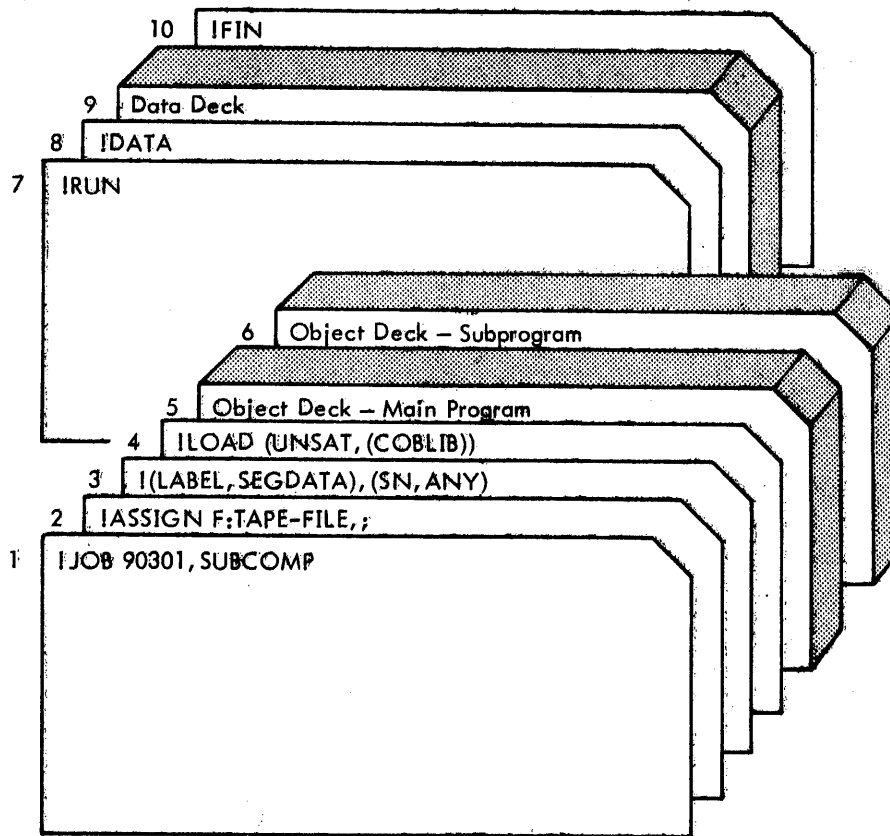

<u>Card</u>	<u>Parameter</u>	<u>Description</u>
1	IJOB 90301 SUBCOMP	Signals the beginning of a job stack. Account number. Identifies the user.
2	IASSIGN F:TAPE-FILE ;	Control command that specifies the file and physical peripheral device to be used. DCB name of TAPE-FILE file. Signals that this ASSIGN command is continued on the following card.
3	I(LABEL, SEGDATA) (SN, ANY)	Specifies that the file is to be named SEGDATA. (This card is part of the preceding ASSIGN command.) Specifies that the file is to be written on any available reel.
4	ILOAD (UNSAT, (COBLIB))	Control command that directs the resident loader to form a relocatable load module. Specifies that the COBOL library (identified by the account name COBLIB) is to be searched for external definitions required for the load module.
5		Object deck of the main program.
6		Object deck of the subprogram.
7	IRUN	Control command that specifies the program is to be executed.

Figure 15. Inter-Program Communication – Execution with Object Decks

<u>Card</u>	<u>Parameter</u>	<u>Description</u>
8	IDATA	Control command that specifies a data deck is to follow.
9		Data deck.
10	IFIN	Signals the end of the job stack.

Figure 15. Inter-Program Communication – Execution with Object Decks (cont.)

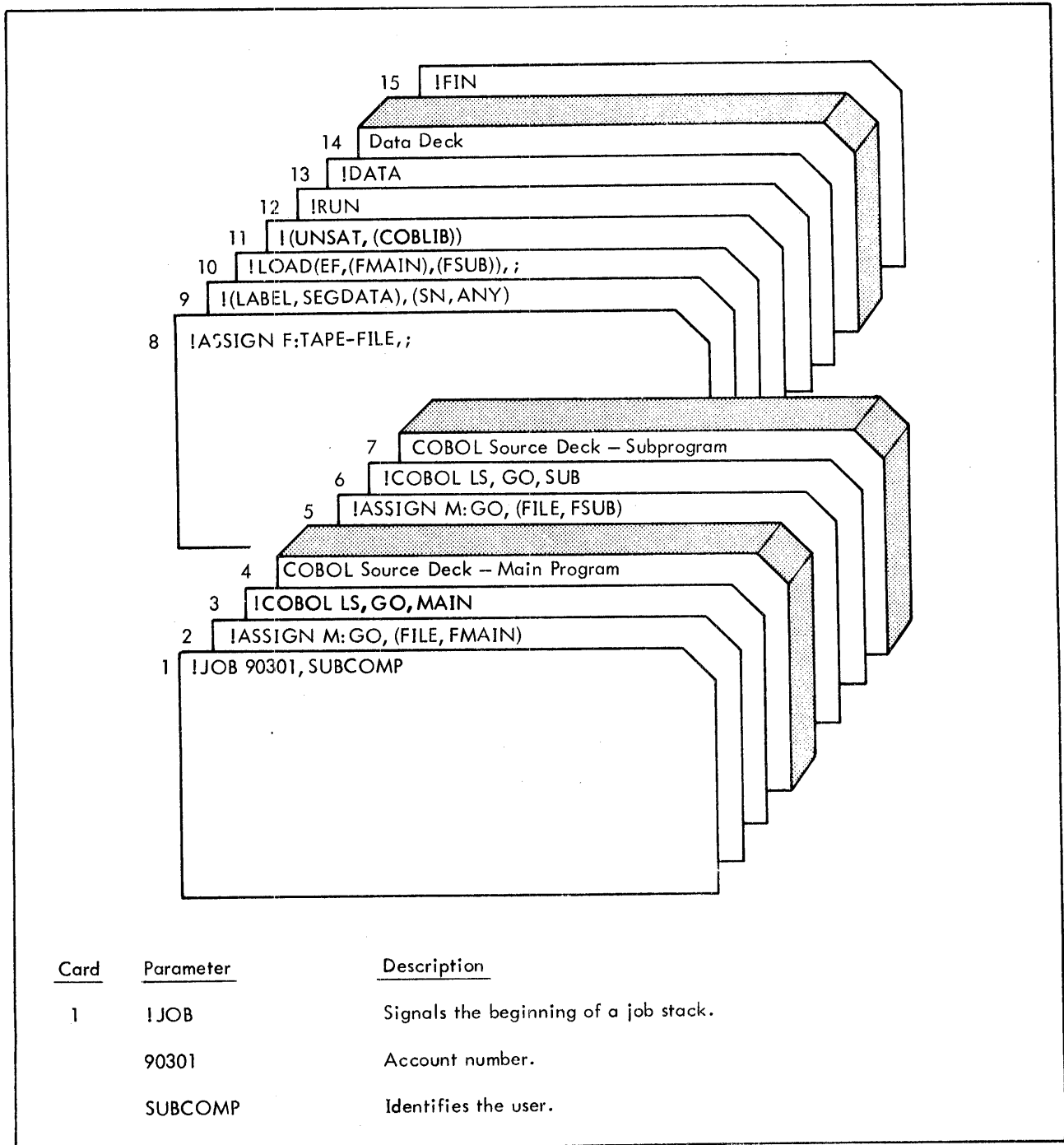

Figure 16. Inter-Program Communication – Compilation and Execution

<u>Card</u>	<u>Parameter</u>	<u>Description</u>
2	IASSIGN	Control command that specifies the file and physical peripheral device to be used.
	M:GO	The file is the system GO file.
	(FILE,FMAIN)	Specifies that the GO file (containing the module of the main or calling program) is to be a disk file named FMAIN.
3	ICOBOL	Control command that specifies control is to be transferred to the COBOL processor.
	LS	Specifies that the source program is to be listed.
	GO	Specifies that the program is to be executed after compilation.
	MAIN	Specifies that this program is to be compiled as the main or calling program.
4		COBOL source deck of the main program.
5	IASSIGN	Control command that specifies the file and physical peripheral device to be used.
	M:GO	The file is the system GO file.
	(FILE,FSUB)	Specifies that the GO file (containing the module of the subprogram or called program) is to be a disk file named FSUB.
6	ICOBOL	Specifies that control is to be transferred to the COBOL processor.
	LS	Specifies that the source program is to be listed.
	GO	Specifies that the program is to be executed after compilation.
	SUB	Specifies that this program is to be compiled as the subprogram or called program.
7		COBOL source deck of the subprogram.
8	IASSIGN	Control command that specifies the file and physical peripheral device to be used.
	F:TAPE-FILE	DCB name of TAPE-FILE file.
	;	Signals that this ASSIGN command is continued on the following card.
9	I(LABEL,SEGDATA)	Specifies that the file is to be named SEGDATA. (This card is part of the preceding ASSIGN command.)
	(SN,ANY)	Specifies that the output file is to be written on any available reel.
10	ILOAD	Control command that directs the resident loader to form a relocatable load module.
	(EF,(FMAIN),(FSUB))	Specifies that modules of the main program (FMAIN) and the subprogram (FSUB) are to be included in the load module.
	;	Signals that this LOAD command is continued on the following card.
11	I(UNSAT,(COBLIB))	Specifies that the COBOL library (identified by account number COBLIB) is to be searched for external definitions required for the load module. (This card is part of the preceding LOAD command.)

Figure 16. Inter-Program Communication – Compilation and Execution (cont.)

Card	Parameter	Description
12	IRUN	Control command that specifies the program is to be executed.
13	IDATA	Control command that specifies a data deck is to follow.
14		Data deck.
15	IFIN	Signals the end of the job stack.

Figure 16. Inter-Program Communication – Compilation and Execution (cont.)

ENTER Statement Feature

The ENTER statement allows the COBOL program to enter any non-COBOL subroutine that the loader can load at object time; for example, a closed machine-language subroutine or a FORTRAN subroutine. The subroutine name must be defined as an entry point.

Figures 17 and 18 show how the subroutine object deck is combined with the COBOL program for compilation and execution.

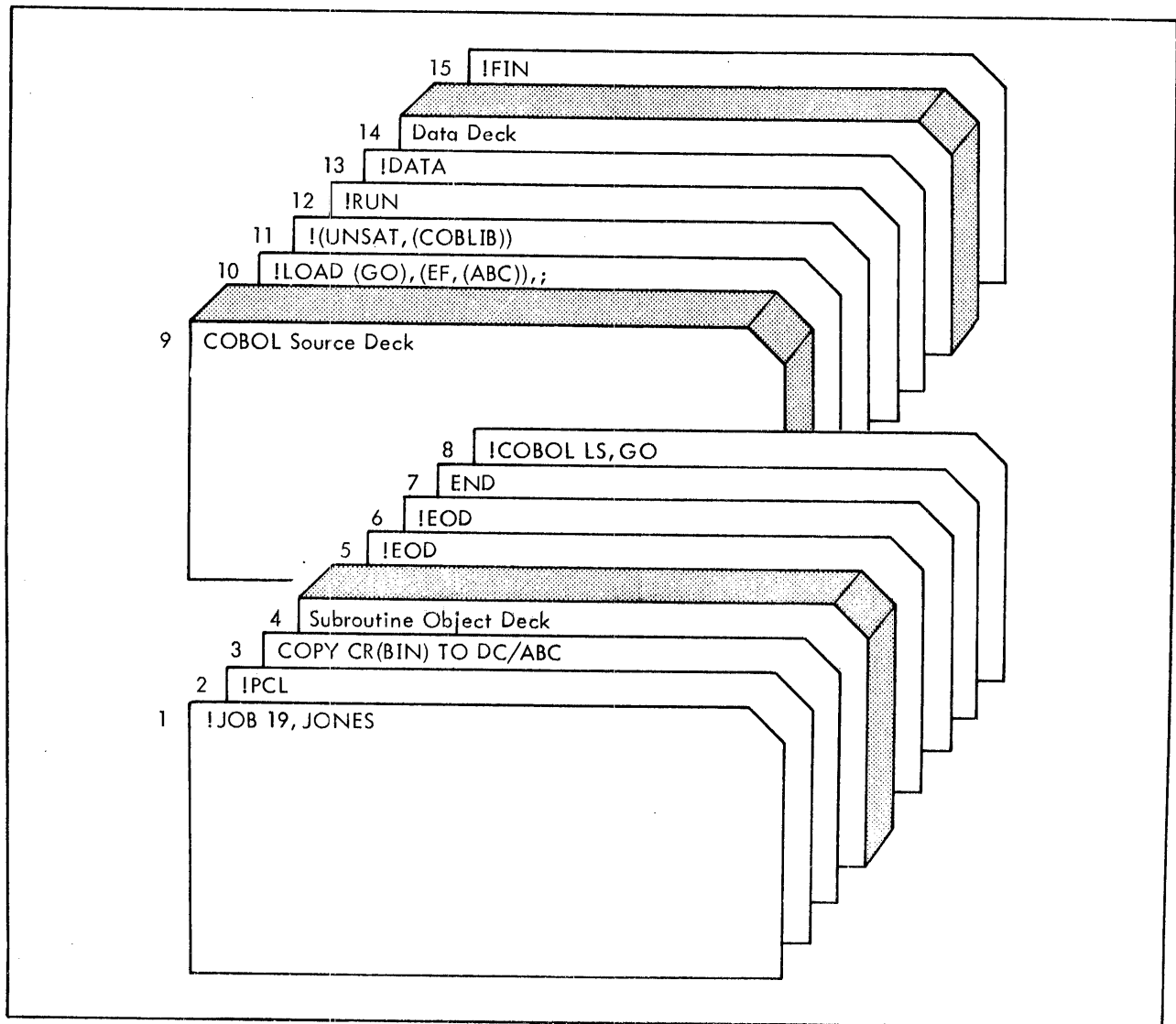
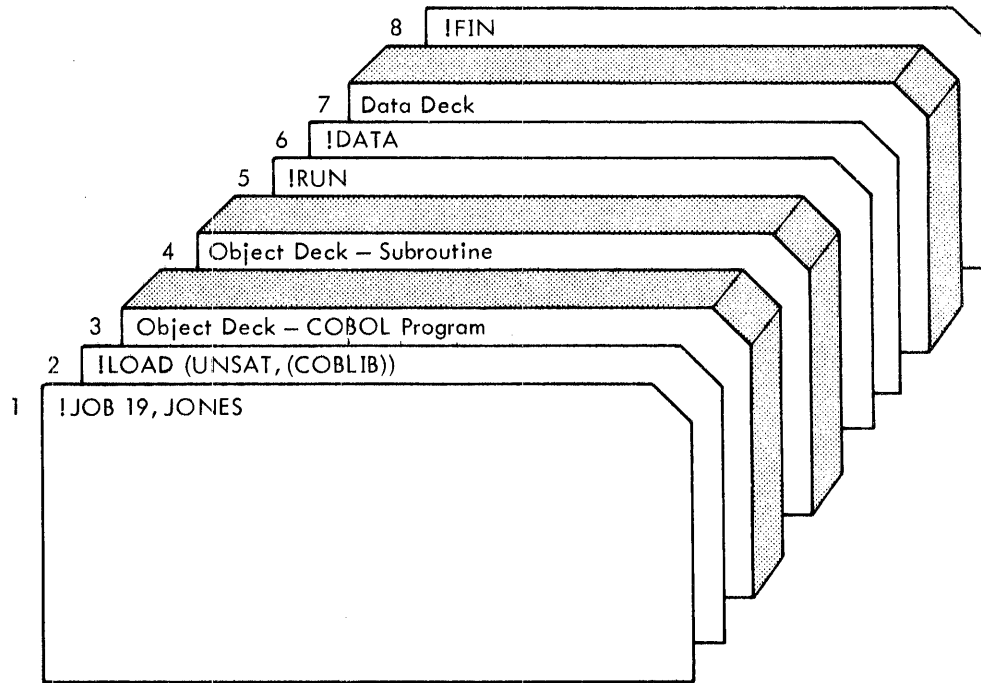

Figure 17. ENTER Statement Feature – Compilation and Execution

<u>Card</u>	<u>Parameter</u>	<u>Description</u>
1	!JOB	Signals the beginning of a job stack.
	19	Account number.
	JONES	Identifies the user.
2	!PCL	Initiates Peripheral Control Language (PCL) processor.
3	COPY CR(BIN) TO DC/ABC	Copies object deck from card reader to disk file name ABC.
4		Subroutine object deck.
5	!EOD	} Signals PCL of the end of the subroutine object deck.
6	!EOD	
7	END	Terminates PCL operations.
8	!COBOL	Control command that specifies control is to be transferred to the COBOL processor.
	LS	Specifies that the source program is to be listed.
	GO	Specifies that the program is to be executed after compilation.
9		COBOL source deck.
10	!LOAD	Control command that directs the resident loader to form a relocatable load module.
	(GO)	Specifies that data from the user temporary GO file is to be included in the root of the load module.
	(EF, (ABC))	Specifies that the module of file ABC is to be included in the load module.
	;	Signals that this LOAD command is continued on the following card.
11	!(UNSAT, (COBLIB))	Specifies that the COBOL library (identified by account number COBLIB) is to be searched for external definitions required for the load module. (This card is part of the preceding LOAD command.)
12	!RUN	Control command that specifies the program is to be executed.
13	!DATA	Control command that specifies a data deck is to follow.
14		Data deck.
15	!FIN	Signals the end of the job stack.

Figure 17. ENTER Statement Feature – Compilation and Execution (cont.)



<u>Card</u>	<u>Parameter</u>	<u>Description</u>
1	!JOB	Signals the beginning of a job stack.
	19	Account number.
	JONES	Identifies the user.
2	!LOAD	Control command that directs the resident loader to form a relocatable load module.
	(UNSAT, (COBLIB))	Specifies that the COBOL library (identified by account number COBLIB) is to be searched for external definitions required for the load module.
3		Object deck of the COBOL program.
4		Object deck of the subroutine.
5	!RUN	Control command that specifies the program is to be executed.
6	!DATA	Control command that specifies a data deck is to follow.
7		Data deck.
8	!FIN	Signals the end of the job stack.

Figure 18. ENTER Statement Feature – Execution with Object Decks

Co-Resident Sort Feature

To use the co-resident sort feature, the names of the Sort processor modules must be communicated to the loader along with the sort TREE structure. The sort TREE structure is generated by the COBOL compiler and is stored in a file on disk under the user program name with two zeros added (for example, ANY00). The user can access this compiler-built TREE structure with a PTREE control command, or he can bypass the compiler-built TREE file and actually supply the same TREE structure with a TREE control command. (The TREE control command is especially useful in changing the TREE structure.) The compiler does not build a TREE for a segmented program that uses the co-resident sort feature.

Figures 19 and 20 show how to compile, load, and execute a COBOL program using co-resident sort. Notice the PTREE control command in this figure (see card 10). Instead of using this command to access the compiler-built TREE structure, the user could have substituted the following TREE control commands to supply the same TREE structure –

```
!TREE ANY-S:SRT-S:DCB1-SSP-(SSP0,SSP1,SSP2,SSP3)
```

if SRTS is specified on the COBOL control command, or if SRTR is specified:

```
!TREE ANY-S:SRT-S:DCB1-SRP-(SRP0,SRP1,SRP2,SRP3)
```

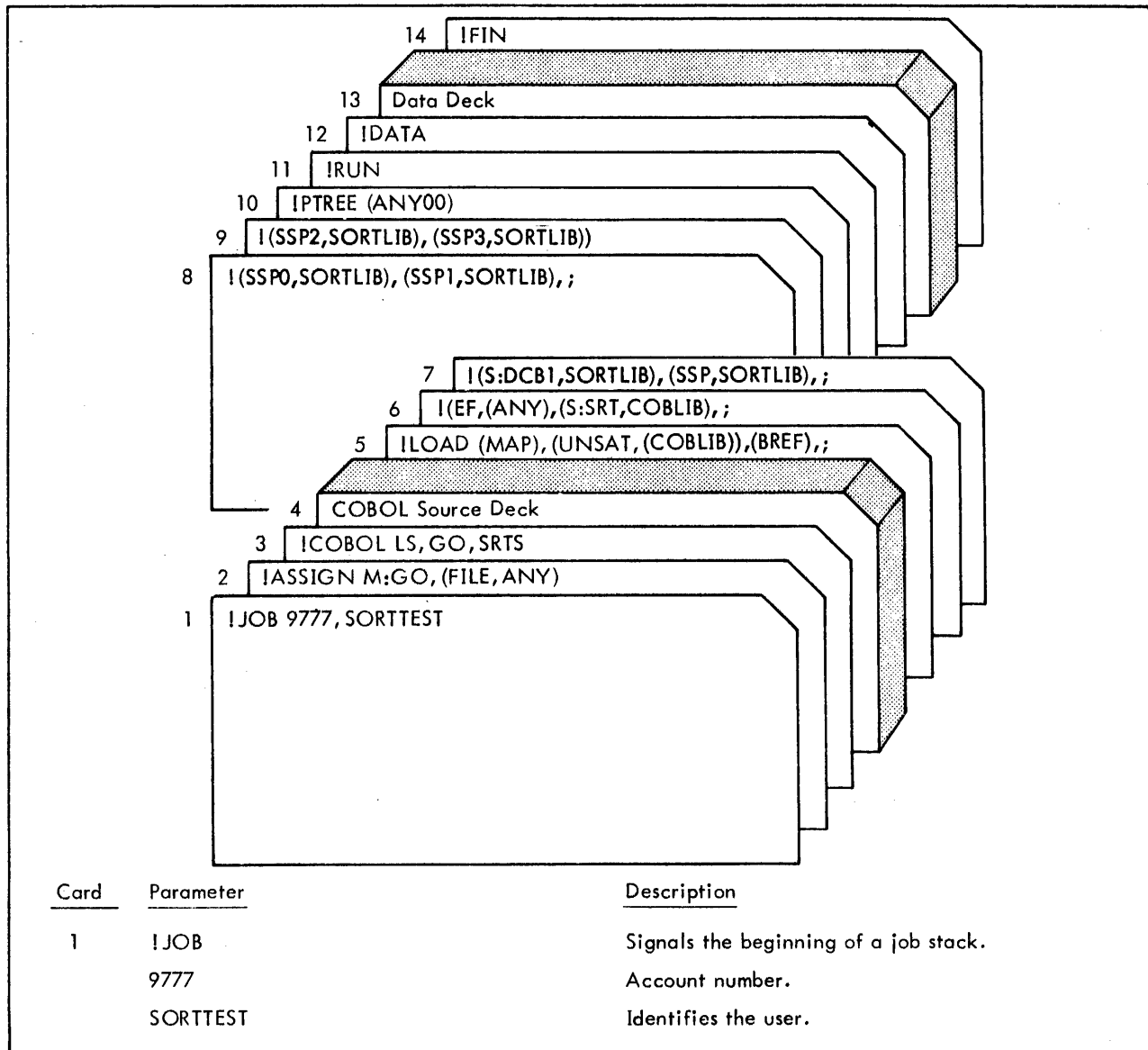

Figure 19. Co-Resident Sort Feature – Compilation and Execution (Sequential Sort Technique)

<u>Card</u>	<u>Parameter</u>	<u>Description</u>
2	IASSIGN M:GO (FILE, ANY)	Control command that specifies the file and physical peripheral device to be used. The file is the system GO file. Specifies that the file is to be a disk file named ANY.
3	ICOBOL LS GO SRTS	Control command that specifies control is to be transferred to the COBOL processor. Specifies that the source program is to be listed. Specifies that the program is to be executed after compilation. Specifies that co-resident sort code is to be generated.
4		COBOL source deck.
5	ILOAD (MAP) (UNSAT, (COBLIB)) (BREF) ;	Control command that directs the resident loader to form a relocatable load module. Gives complete listing of external references and definitions for the load module. Specifies that the COBOL library (identified by account name COBLIB) is to be searched for external definitions required for the load module. Specifies that the branch reference mode of loading is to be used. Signals that this LOAD command is continued on the following card.
6	I(EF, (ANY), (S:SRT, COBLIB))	These cards are all continuation of the LOAD command. They specify that the modules of the root segment ANY, the module S:SRT, and the Sort modules S:DCB1, SSP, SSP0, SSP1, SSP2, and SSP3 are to be included in the load module. S:SRT can be found in account COBLIB, and the Sort module can be found in account SORTLIB.
7	I(S:DCB1, SORTLIB), (SSP, SORTLIB)	
8	I(SSP0, SORTLIB), (SSP1, SORTLIB)	
9	I(SSP2, SORTLIB), (SSP3, SORTLIB)	
10	IPTREE (ANY00)	Control command that is used to obtain the TREE control command from the user's file (named ANY00, which is the name of the program with 00 appended to it).
11	IRUN	Control command that specifies the program is to be executed.
12	IDATA	Control command that specifies a data deck is to follow.
13		Data deck.
14	IFIN	Signals the end of the job stack.

Figure 19. Co-Resident Sort Feature – Compilation and Execution (Sequential Sort Technique) (cont.)

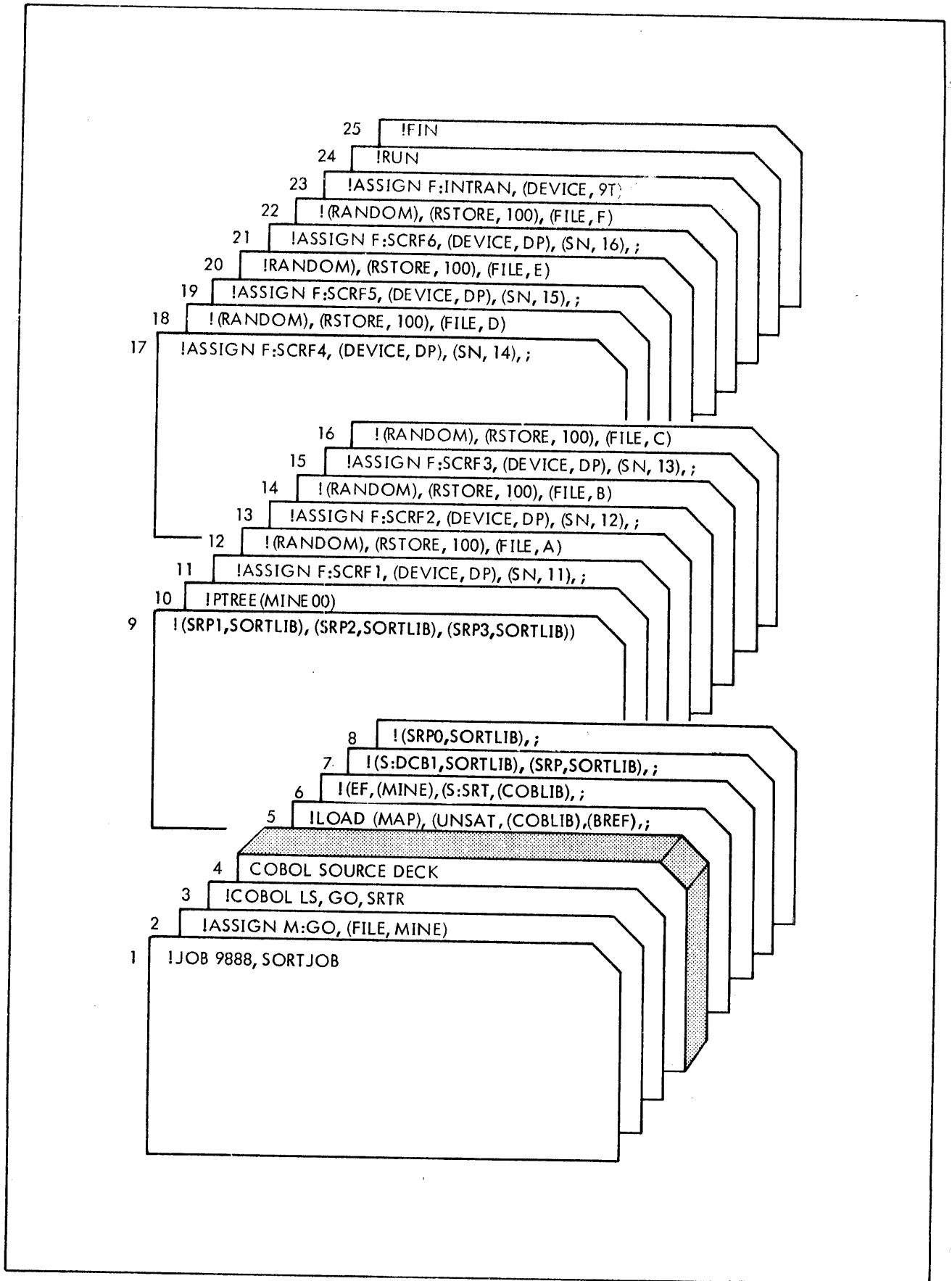

Figure 20. Co-Resident Sort Feature – Compilation and Execution (Random Sort Technique)

<u>Card</u>	<u>Parameter</u>	<u>Description</u>
1	!JOB	Signals the beginning of the job stack.
2	!ASSIGN	Controls command that specifies files characteristics.
	M:GO	The device is the system GO file.
	(FILE,MINE)	This file is a disk file called MINE.
3	ICOBOL	Call and transfer Control to the COBOL compiler.
	LS	List the source program.
	GO	Build a load module of the object program on the GO file.
	SRTR	Specifies that co-resident sort code is to be generated.
4		The COBOL source program deck.
5	!LOAD	Directs the resident loader to form a relocatable load module.
	(MAP)	List the external references and definitions for the load module.
	(UNSAT,COBLIB)	Satisfy external references from COBOL run-time library.
	(BREF)	Specifies that the branch reference mode of loading is to be used.
	;	Signals that the load command continues on the next card.
6	(EF, (MINE), (S:SRT,COBLIB)	These cards are all a continuation of the LOAD command. They specify that the modules of the root segment MINE, the module S:SRT, and Sort modules S:DCB1, SRP, SRP0, SRP1, SRP2, and SRP3 are to be included in the load modules. The module S:SRT can be found in account COBLIB, and the Sort modules can be found in account SORTLIB.
7	(S:DCB1,SORTLIB), (SRP,SORTLIB)	
8	(SRP0,SORTLIB)	
9	(SRP1,SORTLIB), (SRP2,SORTLIB), (SRP3,SORTLIB))	
10	!PTREE (MINE00)	This command will obtain the TREE command from the user's file named MINE00.
11	!ASSIGN F:SCRF1,(DEVICE,DP), (SN,11)	These cards assign the first six of the 17 Sort work file DCBs to six private disk pack files. These files are assigned to RANDOM storage, using 100 granules on each pack.
12	!(RANDOM),(RSTORE,100),(FILE,A)	
13	!ASSIGN F:SCRF2,(DEVICE,DP), (SN,12)	
14	!(RANDOM),(RSTORE,100),(FILE,B)	
15	!ASSIGN F:SCRF3,(DEVICE,DP), (SN,13)	
16	!(RANDOM),(RSTORE,100), (FILE,C)	

Figure 20. Co-Resident Sort Feature – Compilation and Execution (Random Sort Technique) (cont.)

<u>Card</u>	<u>Parameter</u>	<u>Description</u>
17	!ASSIGN F:SCRF4,(DEVICE,DP), (SN,14),	
18	!(RANDOM),(RSTORE,100),(FILE,D)	
19	!ASSIGN F:SCRF5,(DEVICE,DP), (SN,15),	
20	!(RANDOM),(RSTORE,100),(FILE,E)	
21	!ASSIGN F:SCRF6,(DEVICE,DP),(SN,16),	
22	!(RANDOM),(RSTORE,100),(FILE,F)	
23	!ASSIGN F:INTRAN,(DEVICE,9T)	The input data file for this program is called INTRAN and can be found on an unlabeled 9-track device tape.
24	!RUN	This command requests that the compiled object program be executed.
25	!FIN	Signals the end of the job stack.

Figure 20. Co-Resident Sort Feature – Compilation and Execution (Random Sort Technique) (cont.)

The three examples shown below illustrate the use of the co-resident sort with a segmented COBOL program.

Example 1:

Tree structure

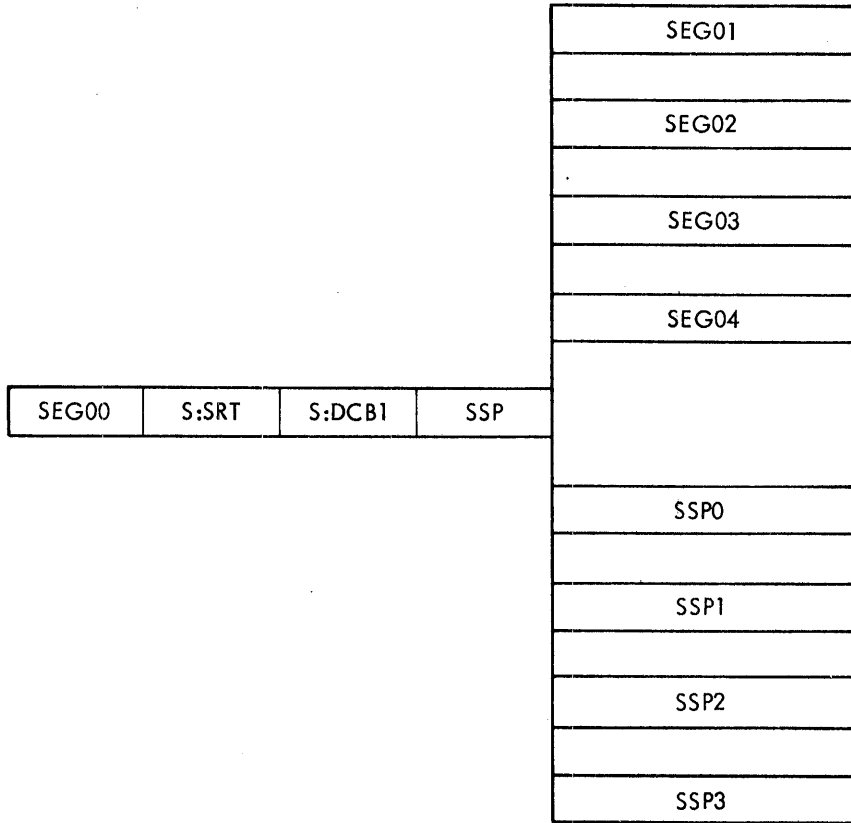

where:

SEG00 is the COBOL root program (section 1) that contains the references to the various overlay segments as well as the section (section 2) that contains the SORT verb and the Input and Output procedure sections.

SEG01 to SEG04 are the overlay segments (section numbers above 49).

Job Control Cards

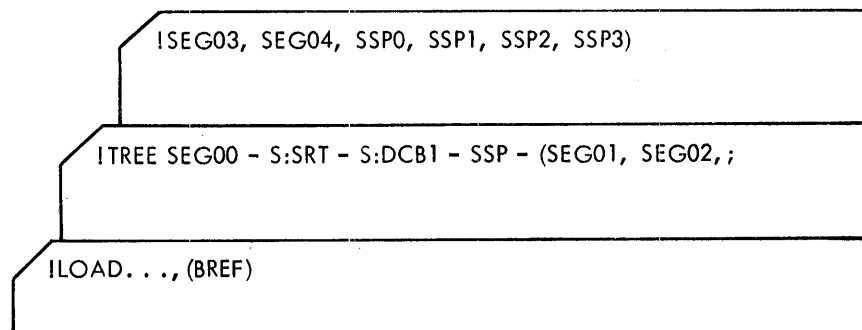

Example 2:

Tree Structure

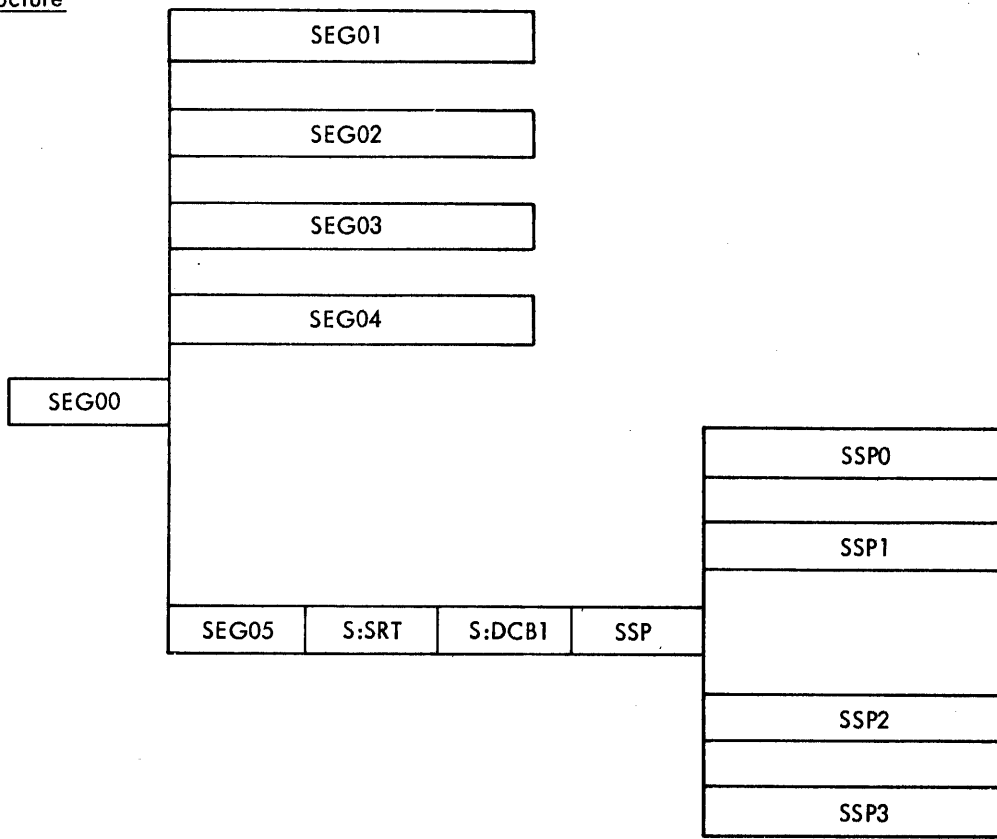

where

SEG00 is the COBOL root program (section 1) that contains all the references to the various overlay segments.

SEG01 to SEG04 are the overlay segments (section numbers above 49).

SEG05 is the overlay segment (section 80) that contains the SORT verb and the Input and Output procedure sections.

Job Control Cards

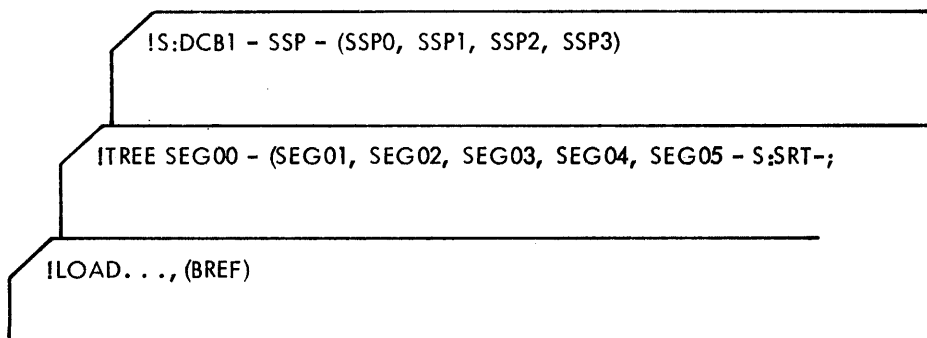

Example 3:

Tree Structure

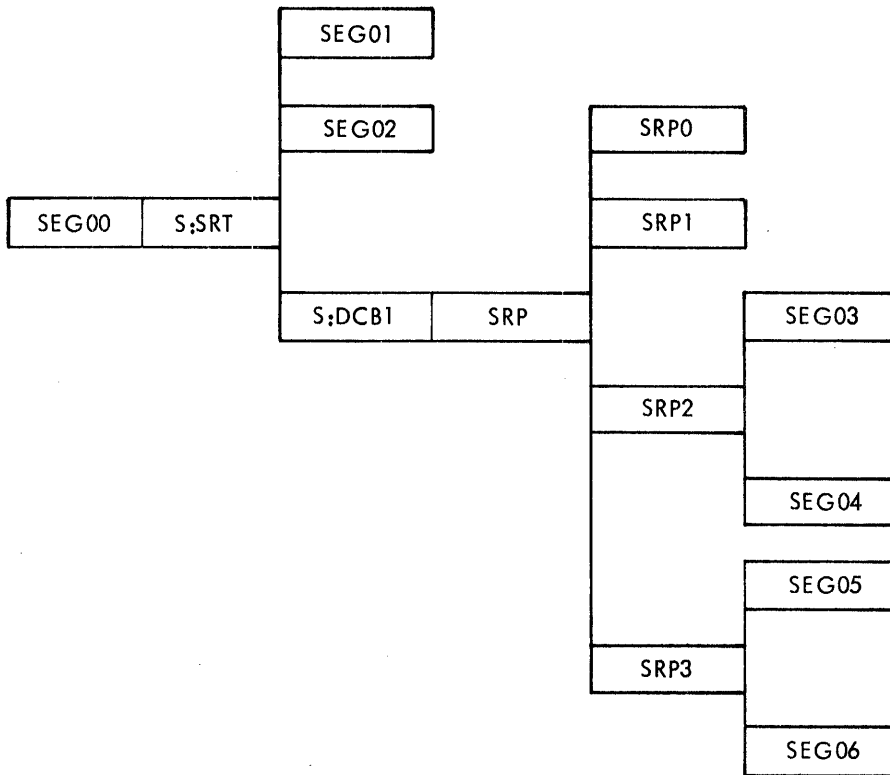

where

SEG00 is the COBOL root program (section 1) that contains references to the various overlay segments as well as the section (section 2) that contains the SORT verb and the Input and Output procedure section.

SEG01 - 02 are overlay segments (section numbers above 49).

SEG03 - 04 are overlay segments in the Input Procedure (SRP2 of SORT) (section numbers above 49).

SEG05 - 06 are overlay segments in the Output Procedure (SRP3 of SORT) (section numbers above 49).

Job Control Cards

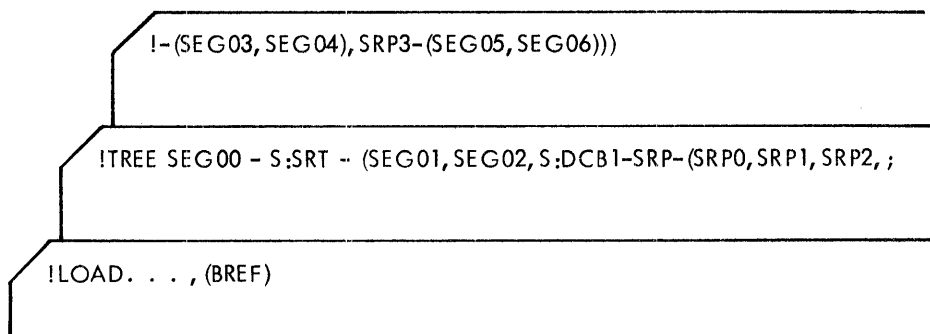

Debug Module Object Time Switch

The object time switch dynamically activates the debugging code inserted by the compiler. If the switch is on, all the effects of the debugging language written in the source program are permitted. If the switch is off, all the effects described in the COBOL Reference Manual are inhibited. Recompile of the source program is not required to provide or eliminate this facility.

The object time switch is normally in the ON position. In order to deactivate the debug code (turn switch to OFF position), the following option in the IRUN control command should be used:

```
IRUN (START,NO$DBG)
```

6. XEROX ANS COBOL COMPILER DIAGNOSTICS

Table 2 lists all diagnostic messages produced by the COBOL compiler. Certain diagnostics are associated with a Strength Code having the following significance:

- P – Precautionary These diagnostics, which are produced only when the DIAG control command option is specified, indicate that a trivial error (or possibility of an error) unaffecting program execution has been detected.
- F – Fatal A serious error has been detected. Compilation is not completed and no object program is produced.

The object program severity level (in hexadecimal) associated with each diagnostic is also shown. Execution of a program bearing a severity level of 7 or greater is not recommended.

Table 2. Xerox ANS COBOL Compiler Diagnostics

Message Number	Message	Strength	Severity Level
001	SOURCE PROGRAM OUT OF SEQUENCE The sequence number field (columns 1 through 6) of the source program lines is tested for ascending sequence only when the SEQCHK control command option is specified.		4
002	INCORRECT PUNCTUATION	P	0
003	AREA A VIOLATION		1
004	NAME/NUMERIC LITERAL EXCEEDS 30 CHARACTERS – TRUNCATED		4
005	INVALID CHARACTER(S)		4
006	QUOTE MARK OMITTED Either the terminating quote of a non-numeric literal has been omitted or a nonblank character has occurred prior to a quote on a continuation line.		4
007	NON-NUMERIC LITERAL EXCEEDS 255 CHARACTERS – TRUNCATED		4
008	RESERVED WORD USED INCORRECTLY – TREATED AS A NAME A reserved word has been encountered in a COBOL division within which it is inapplicable. It receives preliminary treatment as a name.		2
009	DIVISION HEADER INCORRECT OR OMITTED		2
010	PERIOD OMITTED		2
011	REQUIRED SECTION OMITTED		4
012	SECTION OUT OF ORDER		2
013	SECTION DUPLICATED		2
014	REQUIRED PARAGRAPH OMITTED		2
015	PARAGRAPH OUT OF ORDER		2

Table 2. Xerox ANS COBOL Compiler Diagnostics (cont.)

Message Number	Message	Strength	Severity Level
016	PARAGRAPH DUPLICATED		2
017	REQUIRED CLAUSE OMITTED – COMPILATION ABORTED	F	
018	CLAUSE DUPLICATED		2
019	PROCEDURE DIVISION STRUCTURED INCORRECTLY A section header has not preceded the initial PROCEDURE DIVISION statements but has occurred later. This condition conflicts with rules that govern structuring of the PROCEDURE DIVISION, but is harmless in itself.		1
020	REQUIRED WORD MISSING		2
021	MISSING COBOL DIVISION(S) – COMPILATION ABORTED	F	
022	NAME INVALID/OMITTED		7
023	INVALID LITERAL		7
024	INVALID SUBSCRIPT		7
025	CLOSING PARENTHESIS OMITTED		4
026	INVALID NUMBER		7
027	ILLEGAL CURRENCY SIGN		4
028	ILLEGAL PRIORITY-NUMBER		4
029	INCORRECT SWITCH-NAME		4
030	INVALID 'ALL' LITERAL		7
031	CONDITION-NAME OMITTED		7
032	INCOMPLETE 'SAME' CLAUSE		7
033	INVALID/OMITTED QUALIFIER		7
034	UNSELECTED FILE An FD or SD entry has no corresponding SELECT sentence in the FILE-CONTROL paragraph. This is a violation of COBOL rules but is harmless in this implementation if an !ASSIGN command is provided for the file at execution time.		4
035	INVALID LEVEL-NUMBER		7
036	INVALID/OMITTED DATA-NAME		7
037	SECTION HEADER INCORRECT		4
038	SOURCE WORDS BYPASSED		7
039	INVALID INDEXING		7

Table 2. Xerox ANS COBOL Compiler Diagnostics (cont.)

Message Number	Message	Strength	Severity Level
040	FD REPORT CLAUSE REQUIRED – COMPILATION ABORTED An RD entry has not been associated with any file via a REPORT clause on an FD entry. Thus, it is impossible to produce the report.	F	
041	INVALID PICTURE		7
042	'TYPE' AND/OR 'NEXT GROUP' OMITTED OR WRITTEN IMPROPERLY		7
043	CLAUSE WRITTEN ILLEGALLY		7
044	EXCESSIVE REPETITION COUNT IN PICTURE		7
045	INVALID REPETITION COUNT		7
046	ILLEGAL CHARACTER(S) IN PICTURE – 'B' SUBSTITUTED		7
047	ILLEGAL COMBINATION OF PICTURE SYMBOLS – DISCARDED		7
048	EXCESSIVE SIZE SPECIFIED FOR EDITED FIELD – TRUNCATED		7
049	SYNTACTICAL ERROR		7
050	CONDITIONAL STATEMENT INVALID IN CONTEXT A conditional statement has been written at a point where only imperative statements are permissible, e.g., following AT END.		7
051	INCORRECT SUBSCRIPTING/INDEXING		7
052	INCORRECT CLASS TEST		7
053	INCORRECT SIGN TEST		7
054	INCORRECT ARITHMETIC OR LOGICAL EXPRESSION		7
055	CONDITION TOO LIBERAL FOR THIS FORMAT OF 'SEARCH' STATEMENT		7
056	INCORRECT ARITHMETIC-EXPRESSION		7
057	SECTION-NAME OMITTED	P	0
058	PARAGRAPH-NAME OMITTED	P	0
059	NULL PROCEDURE		1
060	PREMATURE END OF PROCEDURE DIVISION A period has not been encountered as the last source language element preceding the end of the source program.		2
061	STATEMENT TOO COMPLEX FOR ANALYSIS Too many levels of nested conditions and/or levels of parenthetical groupings and/or logical connectors have been specified for the statement. A set of simpler statements should be provided to accomplish the desired effect.		7
062	EXCESSIVE NEGATION		6

Table 2. Xerox ANS COBOL Compiler Diagnostics (cont.)

Message Number	Message	Strength	Severity Level
063	NEGATIVE INTEGER – MUST BE UNSIGNED OR POSITIVE		7
064	INTEGER VALUE TOO GREAT		7
065	MNEMONIC-NAME SYNONYM A mnemonic-name and a data-name have been given identical names. This condition is a violation of COBOL rules, but is harmless unless the name has been employed in an ambiguous reference.		2
066	SPECIFICATION CONFLICT Either conflicting USAGES or an illegal combination of USAGE and BLANK WHEN ZERO or JUSTIFIED RIGHT has been specified. The first specification encountered is used; others are discarded.		4
067	MULTIPLE VALUE CLAUSES More than one VALUE clause has been specified in a data entry; the first is used, others are discarded.		4
068	ILLEGAL USE OF 'REDEFINES' The level-number of the data entry bearing the REDEFINES clause has not corresponded to any level-number within the potential redefinition scope. The REDEFINES clause is ignored.		7
069	INCORRECT QUALIFICATION An incorrect qualification in conjunction with a REDEFINES or RENAMES clause has been encountered. The REDEFINES clause is obeyed, since the data-name is not essential to its resolution. The scope of the RENAMES is set arbitrarily to 1 byte and its origin is assumed to be the base of the current record.		7
070	ILLEGAL DATA HIERARCHY Level-66 entries have not been specified as the last entries in a data hierarchy. All entries between the last level-66 entry and the beginning of the next record are discarded.		7
071	INVALID 'RENAMES' SCOPE The extent of a RENAMES scope has been indeterminable; 1 byte is assumed.		7
072	MISPLACED 'RENAMES' CLAUSE The RENAMES clause has not been associated with level-number 66. The RENAMES declaration is ignored.		7
073	CONDITION-NAME ENTRY LACKS 'VALUE' CLAUSE No VALUE clause has been specified on a level-88 entry. The entry is deleted.		7
074	CONDITION-NAME ENTRY BEARS INVALID CLAUSE(S) Clauses other than the VALUE clause have been encountered on a level-88 entry. These clauses are ignored.		7

Table 2. Xerox ANS COBOL Compiler Diagnostics (cont.)

Message Number	Message	Strength	Severity Level
075	MISPLACED 'REDEFINES' CLAUSE The REDEFINES clause has appeared before the occurrence of any legitimate potential redefinition point in the current data hierarchy. The clause is ignored.		7
076	ILLEGAL USE OF 'OCCURS . . . DEPENDING ON' On variable-length records the variable portion of the record must follow the fixed portion. If this rule is violated (that is, if a fixed item or group follows the last variable group of the record), any reference to the fixed item or group will be unpredictable.		7
077	NESTING OF 'OCCURS' EXCEEDS 3 LEVELS An attempt to define a table of more than three dimensions has been detected. The OCCURS clause is ignored.		7
078	MISPLACED 'OCCURS' CLAUSE		7
079	USAGE CONFLICT BETWEEN GROUP AND SUBORDINATE ITEMS A conflict has occurred between the stated USAGE of a group and a subordinate data entry. The description of the subordinate item is accepted.		6
080	MISPLACED 'PICTURE' CLAUSE A PICTURE has been specified in conjunction with one of the USAGE types having predetermined characteristics, e.g., COMPUTATIONAL, COMPUTATIONAL-1, COMPUTATIONAL-2, and INDEX. The PICTURE clause is discarded.	P	0
081	ILLEGAL 'BLANK WHEN ZERO' CLAUSE A BLANK WHEN ZERO clause has been found to be in conjunction with a PICTURE that precludes it, i.e., that is not unsigned numeric DISPLAY or numeric edited. The BLANK WHEN ZERO clause is ignored.		6
082	ILLEGAL 'JUSTIFIED RIGHT' CLAUSE A JUSTIFIED RIGHT clause has been specified on a group item or an elementary item that is not alphanumeric. The JUSTIFIED RIGHT clause is ignored.		6
083	'VALUE' CLAUSE WITHIN SCOPE OF 'REDEFINES' The VALUE is accepted and used in the object program.		6
084	NESTED 'VALUE' CLAUSES The VALUE is accepted and used in the object program.		6
085	'VALUE' CLAUSE INCONSISTENT WITH CLASS OF ENTRY The VALUE is not accepted.		7
086	'OCCURS . . . DEPENDING ON' ILLEGAL WITHIN SCOPE OF 'REDEFINES'		7
087	'PICTURE' CLAUSE ILLEGAL ON GROUP ENTRY The PICTURE is ignored.		6

Table 2. Xerox ANS COBOL Compiler Diagnostics (cont.)

Message Number	Message	Strength	Severity Level
088	NON-UNIQUE DATA REFERENCE		7
089	NON-UNIQUE PROCEDURE-NAME		7
090	INVALID 'DEPENDING ON' FIELD The 'GO TO . . . DEPENDING ON' data item has not been specified as a numeric field. The statement is discarded.		7
091	NON-CONTIGUOUS DATA ITEM FOLLOWING DATA STRUCTURE Level 77 is changed to level 01.		4
092	LEVEL 66 ILLEGAL FOLLOWING LEVEL 77, OR 01		7
093	INVALID DATA USAGE		7
094	MAXIMUM SIZE EXCEEDED FOR NUMERIC OPERAND		7
095	UNDEFINED DATA REFERENCE		7
096	INVALID DATA REFERENCE A condition-name or mnemonic-name has been referenced where a data item is expected.		7
097	VALUE ILLEGAL WITHOUT COLUMN NO. The value is discarded.		7
098	NUMERIC VALUE ILLEGAL IN REPORT SECTION The value is discarded.		7
099	PRIORITY SEGMENTATION IS NOT HONORED IN THIS COMPILATION Priority segmentation has been indicated in the source program without specification of the SEG control command option.		2
100	ILLEGAL LEVEL-NUMBER SEQUENCE The level-number is accepted.		2
101	UNDEFINED KEY No data entry has been specified to satisfy a KEY clause reference. The key name is disregarded.		7
102	SIZE OF DATA ENTRY INDETERMINATE Sufficient information has not been provided to determine the size of a data entry.		7
103	SIZES OF REDEFINING AND REDEFINED AREAS UNEQUAL The size of the largest of these areas is used.		7
104	RENAMES DATA-NAME MISSING No valid RENAMES clause has been specified on a level-66 data entry.		7
105	VALUE LITERAL CONFLICTS WITH CLASS OF DATA ENTRY The value is ignored.		7

Table 2. Xerox ANS COBOL Compiler Diagnostics (cont.)

Message Number	Message	Strength	Severity Level
106	VALUE TRUNCATED ON RIGHT Insufficient storage space has been allocated to the value.		4
107	VALUE TRUNCATED ON LEFT Insufficient storage space has been allocated to the value.		4
108	DUPLICATE DATA-NAMES WHICH CANNOT BE UNIQUELY REFERENCED		2
109	EXCESSIVE NESTING OF LIBRARY RETRIEVAL STATEMENTS – COMPILATION ABORTED	F	
110	PICTURE INCOMPATIBLE WITH USAGE A PICTURE (possibly containing editing characters) incompatible with USAGE COMPUTATIONAL-3 has been specified. The USAGE is discarded.		6
111	INCORRECT 'GO TO' STRUCTURE		7
112	'USE' STATEMENT OMITTED FROM DECLARATIVES SECTION		7
113	POSSIBLE MISUSE OF RESERVED WORD		4
114	NO CORRESPONDING DATA ITEMS IN A 'CORRESPONDING' STATEMENT		7
115	IDENTIFIER IN 'CORRESPONDING' STATEMENT IS AN ELEMENTARY ITEM		7
116	COMPILER LIMITATION EXCEEDED – STATEMENT INCOMPLETELY COMPILED This message occurs when a PERFORM statement (format 4) is too lengthy in its entirety to be compiled.		7
117	INVALID LIBRARY RETRIEVAL STATEMENT – COMPILATION ABORTED The library file does not exist.	F	
118	NUMBER OF RENAMED FILES EXCEEDS COMPILER CAPACITY		B
119	ASSEMBLY PHASE TABLE OVERFLOW – COMPILATION ABORTED There are probably too many section and paragraph definitions.	F	
120	FILLER MEANINGLESS ON LEVEL 77 – ACCEPTED		4
121	CONFLICT BETWEEN 'BLOCK CONTAINS' CLAUSE AND RECORD SIZE		7
122	CANNOT PROCESS DATA STRUCTURE IN CORE AVAILABLE – COMPILATION ABORTED This is a general message indicating that a compiler data storage area has overflowed.	F	
123	REPORT FIELD OVERLAP – DATA ITEM TRUNCATED The report line probably contains conflicting COLUMN NUMBER assignments.		4
124	REPORT STATEMENTS BYPASSED		7

Table 2. Xerox ANS COBOL Compiler Diagnostics (cont.)

Message Number	Message	Strength	Severity Level
125	CONFLICT BETWEEN 'RECORD CONTAINS' CLAUSE AND RECORD SIZE The computed record size is used.		4
126	VACUOUS 'ROUNDED' OPTION – IGNORED Arithmetic operation has not developed digits of lesser significance than the rightmost digit position of the result data item. Thus, rounding is not effected.	P	0
127	'SELECT' SENTENCES DUPLICATED		4
128	ILLEGAL NUMERIC-EDITED USAGE A usage conflict has occurred. A warning is issued.	P	0
129	ILLEGAL FLOATING-POINT USAGE FOR INTEGER An integer value has been used. A warning is issued.	P	0
130	ILLEGAL BINARY/FLOATING POINT USAGE A usage conflict has occurred. A warning is issued.	P	0
131	ILLEGAL INDEX DATA USAGE This is treated as a binary (COMPUTATIONAL) data item. A warning is issued.	P	0
132	ILLEGAL NON-INTEGERS USAGE An integer portion of the data item is used.		4
133	ILLEGAL COMPUTATIONAL-3 USAGE A usage conflict has occurred. A warning is issued.	P	0
134	ILLEGAL ALPHANUMERIC USAGE A usage conflict has occurred. A warning is issued.	P	0
135	ILLEGAL ALPHANUMERIC-EDITED USAGE A usage conflict has occurred. A warning is issued.	P	0
136	MAXIMUM OF 3 IDENTIFIERS ONLY MAY BE VARIED – ENTIRE "PERFORM" STATEMENT DELETED		7
137	ILLEGAL ELEMENTARY ITEM USAGE		7
138	ILLEGAL INDEX-NAME USAGE This is treated as a binary (COMPUTATIONAL) data item.		7
139	PARAGRAPH BOTH ALTERED AND PERFORMED The ALTER and PERFORM statements have been generated. This is a warning of high error probability.		6

Table 2. Xerox ANS COBOL Compiler Diagnostics (cont.)

Message Number	Message	Strength	Severity Level
140	<p>ALTERED PARAGRAPH NOT 'GO TO'</p> <p>A GO TO statement has not been specified as the sole contents of a paragraph that is the subject of an ALTER statement. The termination point of the paragraph is preset to transfer control to C:ERR. If control reaches the paragraph subsequent to the execution of the ALTER statement, control is transferred as specified by the ALTER statement following execution of the statements contained in the paragraph (assuming that no single statement has caused transfer of control).</p>		4
141	<p>INVALID PROCEDURE REFERENCE</p> <p>In most cases, the statement is deleted. In some instances a reference to C:ERR is substituted for the incorrect procedure-name.</p>		7
142	<p>INVALID SECTION-NAME REFERENCE</p> <p>A section-name has been referenced in an ALTER statement, where only paragraphs may be mentioned. The statement is deleted.</p>		7
143	<p>EXTERNAL NAME ALTERED TO PROCEED TO OVERLAY</p> <p>An undefined procedure-name, which is therefore presumed to be an external definition, has been altered to proceed to a point in an overlay segment. Unless the ALTER statement itself is in the same overlay segment, C:ERR is substituted for the target procedure-name.</p>		7
144	<p>INVALID PARAGRAPH-NAME REFERENCE</p> <p>A paragraph-name has occurred where only a section-name is permissible, e.g., as the INPUT or OUTPUT PROCEDURE of a SORT. This is a warning of the probability of error. The requested action is taken.</p>		7
145	INTEGER VALUE ILLEGAL IN CONTEXT		7
146	'SET' USED WITH NON-INDEXED FIELD		7
147	<p>'GO TO' INITIALIZED AT C:ERR</p> <p>Comment only. GO TO statements are preset to transfer control to C:ERR if an ALTER statement has not provided a legitimate transfer point prior to its execution.</p>	P	0
148	<p>INVALID FILE-NAME</p> <p>A file-name has not appeared as the operand of a statement requiring one. The statement is deleted.</p>		B
149	<p>INVALID RECORD-NAME</p> <p>A record-name has not appeared as the operand of a statement requiring one. The statement is deleted.</p>		7
150	<p>LABEL/ERROR CHECK IN DECLARATIVES SECTION</p> <p>An input-output statement that requires execution of a DECLARATIVES procedure has occurred within a DECLARATIVES procedure. The statement is generated, but may yield erroneous results (e.g., a loop) at execution time.</p>		7

Table 2. Xerox ANS COBOL Compiler Diagnostics (cont.)

Message Number	Message	Strength	Severity Level
151	INVALID REVERSED/NO REWIND OPTION Specified input/output statement options are incompatible with the access mode of the file. The options are deleted.		7
152	AT END/INVALID KEY OPTION INCOMPATIBLE WITH ACCESS MODE Specified input/output statement options are incompatible with the access mode of the file. A warning is issued. The statement is generated as written.		7
153	'SEEK' USED WITH UN-KEYED FILE Specification of the SEEK statement is incompatible with the organization and access mode of the file. The statement is deleted.		7
154	INVALID KEY The ACTUAL KEY has been undefined, defined twice, or judged incompatible with the access mode of the file.		7
155	MAXIMUM DISPLAY SIZE EXCEEDED The aggregate size of operands in a DISPLAY, EXHIBIT, ACCEPT, or STOP 'literal' statement has exceeded 254 characters. The display line is truncated.		6
156	ILLEGAL SUBSCRIPTED 'DEPENDING ON' FIELD Subscripts are ignored.		7
157	NON-TABLE ITEM SEARCH The statement is deleted.		B
158	'SEARCH ALL' UNORDERED TABLE ILLEGAL A warning is issued. A serial search of the entire table is generated.		B
159	EXTERNAL REFERENCE GENERATED This message is commentary only and indicates generation of a reference to an assumed external definition.	P	0
160	UNDEFINED PARAMETER-NAME The presence of qualification indicates that this external reference is not intentional. A reference to C:ERR is substituted.		7
161	CONDITION-NAME USED AS PARAMETER A reference to the conditional variable is substituted for the condition-name.		7
162	DIMENSIONED PARAMETER Parameters are not permitted to be subscripted/indexed. Subscripts are ignored and a reference to the first occurrence is generated.		7
163	INDEX-NAME USED AS PARAMETER A warning is issued. Reference to the index-name is generated.		7

Table 2. Xerox ANS COBOL Compiler Diagnostics (cont.)

Message Number	Message	Strength	Severity Level
164	SUBSCRIPTS/INDICES APPLIED TO UNDIMENSIONED DATA ITEM The subscripts/indices are ignored.		7
165	INVALID SUBSCRIPTS/INDICES The subscripts/indices are ignored and reference is made to the first occurrence.		7
166	EXCESSIVE SUBSCRIPTS/INDICES The excess subscripts/indices are discarded.		7
167	MAXIMUM SUBSCRIPT SIZE EXCEEDED The offending subscript is replaced by a value of 1 so that the first occurrence is referenced.		7
168	FRACTION USED AS SUBSCRIPT A data item, which bears fractional places only, has been used as a subscript. The offending subscript is replaced by a value of 1 so that the first occurrence is referenced.		7
169	SIGNIFICANCE LOST WHEN ALIGNED A data item whose PICTURE contains trailing Ps has been employed as a subscript. The scaled value is used.		7
170	INCORRECT SUBSCRIPT/INDEX		7
171	FLOATING POINT SUBSCRIPT – INTEGER VALUE ONLY USED		6
172	SUBSCRIPTED TABLE ITEM Subscripting has been specified where indexing should be employed. The subscripted reference is generated.		4
173	SUBSCRIPT INCREMENT/DECREMENT USED The increment/decrement has been applied to the subscript and a subscripted reference is generated.		6
174	INEFFECTIVE DIGITS TRUNCATED A decimal item used a subscript of sufficient size that insignificant digits may be truncated by the subscript calculation.		4
175	NON-INTEGERSUBSCRIPT – INTEGER VALUE USED		4
176	DIMENSIONED SUBSCRIPT The value in the first occurrence of the array whose name has been given as a subscript is employed in the subscript calculation.		7
177	INSUFFICIENT SUBSCRIPTS/INDICES A value of 1 is assumed for each missing subscript/index.		7
178	DIMENSIONED DATA NOT SUBSCRIPTED/INDEXED A value of 1 is assumed for each missing subscript/index.		7

Table 2. Xerox ANS COBOL Compiler Diagnostics (cont.)

Message Number	Message	Strength	Severity Level
179	MAXIMUM SORT KEY LENGTH EXCEEDED – 255 CHARACTER USED		7
180	INVALID CS NAME – IGNORED The CS (COMMON-STORAGE) control command parameter has been written incorrectly.		B
181	INVALID CONTROL COMMAND OPTION – IGNORED An unrecognizable control command option has been encountered and is ignored.		6
182	ILLEGAL RELATION TEST. ONLY CONDITION-NAME TEST GENERATED A relation test involving a condition-name test has been written improperly. The condition-name test is generated but the balance of the conditional statement is deleted.		7
183	ILLEGAL OPERAND IN COMPARISON – COMPARISON DELETED An illegal comparand (object) has been detected. The comparison is deleted.		7
184	ILLEGAL SUBJECT IN RELATION TEST. STATEMENT DELETED An illegal subject has been detected. The entire conditional statement is deleted.		7
185	ILLEGAL RELATION TEST An illegal implication has been detected. The entire conditional statement is deleted.		7
186	RELEASE/RETURN NOT AN INPUT/OUTPUT PROCEDURE The RELEASE/RETURN statement is deleted.		7
187	SORT STATEMENT WITHIN INPUT/OUTPUT PROCEDURE – DELETED		B
188	SORT KEY NOT IN SORT-FILE RECORD DESCRIPTION The incorrect SORT key specification is ignored.		B
189	NO SORT KEYS The SORT statement is deleted.		B
190	EXCESSIVE SORT KEYS Excessive SORT keys (the maximum is 16) are ignored.		B
191	INVALID REPORT RECORD The GENERATE statement has not referenced a report-name or a report record-name. The statement is deleted.		B
192	INVALID DATA REFERENCE – EXPRESSION DELETED An expression operand has not been defined. The expression is deleted.		B

Table 2. Xerox ANS COBOL Compiler Diagnostics (cont.)

Message Number	Message	Strength	Severity Level
193	INVALID EXPRESSION OPERAND – EXPRESSION DELETED An illegal arithmetic operand has occurred within an expression. The expression is deleted.		B
194	INVALID EXPRESSION – DELETED An expression has been malformed and is deleted.		B
195	UNBALANCED EXPRESSION – DELETED An imbalance of operators and operands has been detected in an expression. The expression is deleted.		B
196	SUM ADDENDS NOT DEFINED IN A DETAIL OR OTHER SUM ITEM The undefined SUM clause operands are deleted.		B
197	INCOMPATIBLE LINE NUMBERS GIVEN IN 'PAGE LIMITS' CLAUSE Compilation is continued in accordance with the dictates of the source program, but erroneous results are likely if the object program is executed.		B
198	NO FD, SD ENTRY ASSOCIATED WITH A 'SELECT' CLAUSE – COMPILATION ABORTED	F	
199	DUPLICATE FD/SD ENTRIES		B
200	CONFLICT BETWEEN "ACCESS MODE" AND "ACTUAL KEY" – RANDOM ACCESS ASSUMED		6
201	CONFLICT BETWEEN "ACCESS MODE" AND "ACTUAL KEY" – SEQUENTIAL ACCESS ASSUMED		6
202	MAXIMUM ACTUAL KEY SIZE EXCEEDED – 255 CHARACTERS USED		6
203	"END DECLARATIVES" STATEMENT MISSING		B
204	MAXIMUM NUMBER OF SELECT STATEMENTS EXCEEDED – COMPILATION ABORTED	F	
205	MORE THAN 3 FD'S ASSOCIATED WITH 1 RD – IGNORED		7
206	VALUE CLAUSE NOT ALLOWED – COMPILATION ABORTED	F	
207	LEVEL 66 DATA ENTRY BEARS INVALID CLAUSE(S)		7
208	EXCESSIVE CHARACTERS IN PICTURE STRING – TRUNCATED		7
209	A "RENAMING" STATEMENT CANNOT BE HONORED		B
210	RIGHTMOST AND/OR FRACTIONAL DIGITS TRUNCATED	P	0
211	LEFTMOST DIGITS/CHARACTERS TRUNCATED	P	0
212	INTEGER AND FRACTIONAL DIGITS TRUNCATED	P	0
213	LEVEL 77 ILLEGAL IN FILE SECTION – DATA ENTRY DISCARDED		7
214	DUPLICATE OR INVALID RD NAME – COMPILATION ABORTED	F	

Table 2. Xerox ANS COBOL Compiler Diagnostics (cont.)

Message Number	Message	Strength	Severity Level
215	VALUE CLAUSE WITHIN SCOPE OF OCCURS The VALUE clause is not permitted within the scope of an OCCURS clause.		7
216	OCCURS ILLEGAL ON LEVEL 01 OR 77		7
217	DECLARATIVE IS NOT APPROPRIATE ON FILE WITH LABEL RECORDS OMITTED		7
218	ILLEGAL CONTINUATION CHARACTER – IGNORED An illegal character in column 7 was encountered.		4
219	DECLARED DATA STORAGE EXCEEDS AVAILABLE CORE STORAGE		7
220	DUPLICATE DECLARATIVES HAVE BEEN SPECIFIED		7
221	INTEGER PERFORM COUNT LIMIT OF (2**19)-1 EXCEEDED – VALUE TRUNCATED		7
222	COMPILER LIMIT OF 9 REPORT CONTROL FIELDS EXCEEDED – COMPILATION ABORTED	F	
223	USAGE NOT SPECIFIED – NUMERIC DISPLAY ASSUMED		4
224	KEYED FILE BLOCKING PRE-EMPTED BY MONITOR – CLAUSE IGNORED The BLOCK CONTAINS clause may not be specified for a keyed file.		3
225	SIZE IN NUMERIC PICTURE GREATER THAN 31 – RESULTS ARE UNPREDICTABLE Numeric items may not exceed PICTURE 9(31). If this is a filler item, change to PICTURE X(n).		2
226	CAUTION NO RECORD DESCRIBED – VALID IF REPORT CLAUSE PRESENT	P	0
227	WARNING – PROCEDURE NAME PASSED IN ENTER STATEMENT IN AN OVERLAY SEGMENT	P	0
228	OPTION OF DEBUGGING MISSING/INVALID		7
229	COPY REPLACING STATEMENT INCORRECTLY STRUCTURED		7
230	DEVICE NOT SPECIFIED – CONSOLE ASSUMED The ACCEPT statement did not specify a device.		2
231	IDENTIFIER NOT SPECIFIED FOR "ACCEPT" STATEMENT		7
232	USAGE NOT SPECIFIED – DISPLAY ASSUMED DISPLAY was not specified in a USAGE clause in a report group entry.		1
233	MAXIMUM DCB SIZE EXCEEDED – 3 INSN/OUTSNS GENERATED The value of "integer" in a SELECT statement is too large; the value of 3 is used.		B

Table 2. Xerox ANS COBOL Compiler Diagnostics (cont.)

Message Number	Message	Strength	Severity Level
234	UNDEFINED PROCEDURE NAME – EXTERNAL REFERENCE GENERATED		7
235	SOURCE INPUT EXCEEDS 72 CHARACTERS – TRUNCATED		7
236	REMAINDER NOT ALLOWED ON DIVIDE WITH MULTIPLE RECEIVING FIELDS		7
237	SUBSCRIPTED 'DEPENDING ON' DATA-NAME – COMPILATION ABORTED The data-name in an OCCURS DEPENDING ON clause may not be subscripted.	F	
238	'OCCURS DEPENDING ON' ENTRIES EXCEEDED LIMIT 15 – COMPILATION ABORTED A maximum of 15 variable groups is allowed for each record description.	F	
239	OPTION OF DELIMITED MISSING/INVALID		7
240	IDENTIFIER MISSING/INVALID AFTER 'IN'/'OF'		7
241	REQUIRED WORD 'RUN' OR LITERAL MISSING AFTER 'STOP'		7
242	REQUIRED WORD 'INTO' OR 'BY' MISSING		7
243	FILE-NAME OR REQUIRED WORD(S) 'REVERSED'/'NO REWIND' MISSING		7
244	REQUIRED WORD(S) MISSING AFTER 'TALLYING' OR 'REPLACING'		7
245	REQUIRED WORD 'TALLYING' OR 'REPLACING' MISSING		7
246	REQUIRED WORD 'TO' MISSING		7
247	REQUIRED WORD 'DEPENDING' MISSING		7
248	REQUIRED WORD 'TIMES'/'UNTIL'/'VARYING' MISSING		7
249	REQUIRED WORD 'INTO'/'END'/'INVALID' MISSING		7
250	REQUIRED WORD 'FROM' MISSING		7
251	REQUIRED WORD 'UNTIL' MISSING		7
252	REQUIRED WORD 'ELSE' MISSING		7
253	REQUIRED WORD 'WHEN' MISSING		7
254	REQUIRED WORD(S) 'LOCK' OR 'NO REWIND' MISSING		7
255	REQUIRED WORD(S) 'TO'/'UP BY'/'DOWN BY' MISSING		7
256	REQUIRED WORD 'INPUT'/'OUTPUT'/'I-O' MISSING		7
257	FILE-NAME MISSING		7
258	LITERAL MISSING AFTER 'ALL'/'LEADING'/'FIRST'		7

Table 2. Xerox ANS COBOL Compiler Diagnostics (cont.)

Message Number	Message	Strength	Severity Level
259	LITERAL MISSING AFTER 'BY'		7
260	IDENTIFIER/INTEGER/MNEMONIC-NAME MISSING AFTER 'BEFORE/ AFTER ADVANCING'		7
261	RECORD-NAME MISSING AFTER 'WRITE'		7
262	IDENTIFIER/LITERAL /INDEX-NAME MISSING AFTER 'FROM'/ 'TO'/'BY'		7
263	IDENTIFIER MISSING AFTER 'TO'		7
264	IDENTIFIER MISSING AFTER 'TO'/'GIVING'		7
265	IDENTIFIER MISSING AFTER 'COMPUTE'		7
266	IDENTIFIER MISSING AFTER 'INSPECT'		7
267	IDENTIFIER MISSING AFTER 'DEPENDING ON'		7
268	IDENTIFIER MISSING AFTER 'INTO'		7
269	IDENTIFIER MISSING AFTER 'FROM'		7
270	IDENTIFIER MISSING AFTER 'SEARCH'		7
271	IDENTIFIER MISSING AFTER 'ACCEPT'		7
272	PROCEDURE-NAME MISSING		7
273	MISSING/INCORRECT STATEMENT AFTER 'AT END'/'INVALID KEY'/'SIZE ERROR'		7
274	REQUIRED WORD(S) 'NEXT SENTENCE' MISSING		7
275	SUBROUTINE-NAME MISSING AFTER 'ENTER'		7
276	IDENTIFIER/LITERAL INVALID OR MISSING		7
277	IDENTIFIER/INDEX-NAME MISSING AFTER 'VARYING'/'SET'/'AFTER'		7
278	IDENTIFIER/LITERAL MISSING AFTER 'INTO'/'FROM'/'BY'		7
279	NUMBER OF USE STATEMENTS EXCEEDS 64--COMPILATION ABORTED	F	
280	SIZE FOR THIS SECTION HAS EXCEEDED 65K		7
281	UNDEFINED/INVALID REPORT NAME		2
282	NOT ENOUGH DYNAMIC MEMORY--COMPILATION ABORTED	F	B
283	SOURCE IMAGE EXCEEDED 80 CHARACTERS -- TRUNCATED	P	0
284	SOURCE IMAGE EXCEEDED 140 CHARACTERS--COMPILATION ABORTED	F	B
285	INVALID/MISSING REPORT RECORD--COMPILATION ABORTED	F	B
286	UNDEFINED CONTROL FIELD, IGNORED		7
287	INVALID DATA USAGE IN CLASS TEST		4

7. RUN-TIME SUBROUTINES, SERVICES AND DIAGNOSTICS

Library Subroutines

Table 3 shows subroutines contained in the system library that may be referenced by COBOL object programs.

Table 3. COBOL Object Program Subroutines

Element File	Entry Points	Function
C:ALT	C:ALT	ALTER of an overlay segment handler
C:BIS	C:BIS	Binary search subroutine
C:CBP	C:CBP	Alphanumeric comparison overlap handler
C:CHKPT	C:CKP C:INT C:MIN C:TIM	Checkpoint routines Record checkpoints !INT key-in entry point CLOCK-UNITS (minutes) value Timer interrupt routine
C:CONV	C:CBD C:CDB C:CDE C:CDF C:CED C:CFD C:DBD C:DED C:DFD	Data conversion subroutines Binary to packed decimal Packed decimal to binary Packed decimal to floating-point short format Packed decimal to floating-point long format Floating-point short format to packed decimal Floating-point long format to packed decimal Binary to unpacked decimal Floating-point short format to unpacked decimal Floating-point long format to unpacked decimal
C:DECL	C:ABF C:ABR C:AEF C:AER C:BBF C:BBR C:BEF C:BER C:CLD	I/O label declaratives handler After beginning file label After beginning reel label After ending file label After ending reel label Before beginning file label Before beginning reel label Before ending file label Before ending reel label Close

Table 3. COBOL Object Program Subroutines (cont.)

Element File	Entry Points	Function
C:DECL (cont.)	C:ERD C:OPD C:RLD C:WLD	Error declaratives Open Read Write
C:DPD	C:DPD	Double precision division
C:DPM	C:DPM	Double precision multiplication
C:ERR	C:ERR	Illegitimate control transfers handler
C:EXP	C:EXP	Interface for exponentiation routines
C:INS	C:INS	Run-time routine for INSPECT
C:LIO	C:ABA C:CIB C:CLS C:ERA C:OPN C:RLR C:WLR C:WOB	Input/output handlers Abnormal return Close input buffer Close a DCB Error return Open a DCB Read Write Write output block
C:NTS	C:NTS	Run-time routine for UNSTRING
C:NCRS	C:SRT	Bypassing co-resident sort
C:RND	C:RND	Arithmetic rounding subroutine
C:STN	C:STN	Run-time routine for STRING
C:SZT	C:SZT	Size error testing

Table 3. COBOL Object Program Subroutines (cont.)

Element File	Entry Points	Function
C:TRC	C:TRC C:TRX	Trace control subroutine
C:TRP	C:TRP C:TRN	Trap handler Trap processor Abort suppression flag
C:RRG	C:RRA C:RRB C:RRC C:RRD C:RRE C:RRF C:RRG C:RRH C:RRI C:RRJ C:RRK C:RRQ C:RRR C:RRS C:RRT C:RRU C:RRV C:RRW C:RRX C:RRY C:RRZ	Report Writer subroutines Return point from Declarative routine and GROUP INDICATE presetting Return point from summing (control footing level) Return point from print line formation Return point from SUM counter resetting Return point from control field preservation Return point from summing (detail level) GENERATE entry point TERMINATE entry point INITIATE entry point Return point from GROUP INDICATE clearing Entry point for erroneous use of report with no prior INITIATE statement Return point from control break testing – no break Return point upon control break at level 1 Return point upon control break at level 2 Return point upon control break at level 3 Return point upon control break at level 4 Return point upon control break at level 5 Return point upon control break at level 6 Return point upon control break at level 7 Return point upon control break at level 8 Return point upon control break at level 9
C:VPL	C:VPL	Variable records handler

Subprogram Calls

The ENTER subroutine-name statement as implemented in the Xerox ANS COBOL language causes generation of a calling sequence to the external definition subroutine-name. All such calling sequences are issued in the form of Xerox Standard Calling Sequences:

1. The number of arguments is passed in register 14.
2. The linking register is 15.

Each parameter is represented in the pointer word vector by a single word whose format is

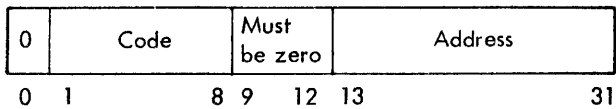

where

Bit 0 indicates whether the Address field is indirect. (COBOL issues direct references only; thus, this bit is always zero.)

Code field }
Address field } are filled as follows:

Data Type	COBOL Description	Bit Value of Code Field	Contents of Address Field
Binary	INDEX or COMPUTATIONAL	00000010	WA (parameter)
Floating short	COMPUTATIONAL-1	00000100	WA (parameter)
Floating long	COMPUTATIONAL-2	00001000	WA (parameter)
Packed decimal	COMPUTATIONAL-3	100xxx0 ^t	BA (parameter)
EBCDIC	DISPLAY	10100000	BA (parameter)
DCB (Data Control Block)	file-name	10100011	WA (parameter)
Program location	procedure-name	00000001	WA (parameter)
^t xxxx (bits 4 through 7) indicates decimal length is in the same format as the Decimal Instructions.			

Special Interfaces to Hardware and Monitor Services

The capabilities described in this section are implemented in the form of assembly language routines that can be added to the run-time library at the user's option. Each routine is independent and any combination of services can be elected for a given installation. In general, these routines contain Xerox defined entry points which the user programmer cites by symbolic name in an ENTER verb in his COBOL syntax. The ENTER for each routine must generally contain a string of data names which (at run-time) contain parameter values defining the nature of the service to be provided. The order of the parameters is strictly defined and it is the user's responsibility to provide the correct values. In effect, these routines are "super-macros" for providing services not available in the Xerox ANS COBOL language.

The specifications below define the service to be provided and the anticipated ENTER syntax required. Some of the individual services may be implemented, as subsections of one run-time routine, thereby requiring a somewhat smaller total number of machine language programs in the run-time library.

The services provided are

1. Delete a record from a keyed file.

The user's file must have been the subject of an "OPEN INPUT-OUTPUT" statement. In this case, the value to be used as the monitor key will be picked up from the user's data area and used in an M:DELREC call.

User Syntax:

```
ENTER DELETER file-name, data-name-1, data-name-2[, procedure-name]
```

where

DELETER is the entry point in the run-time routine.

file-name is the appropriate FD name.

data-name-1 contains the monitor record key (DISPLAY).

data-name-2 contains the length of data-name-1 (COMPUTATIONAL).

procedure-name is to be executed if the specified key is not found in the file. This parameter is optional.

2. Get the monitor key and actual record size of the last processed record in a file.

The required values are abstracted from the KBUF and ARS areas of the DCB.

User Syntax:

```
ENTER LASTKEY file-name, data-name-1, data-name-2[, data-name-3]
```

where

LASTKEY is the entry point in the run-time routine.

file-name is the appropriate FD name.

data-name-1 is the area into which the monitor key of the last record read or written will be inserted (DISPLAY).

data-name-2 is the area into which the length of the monitor key will be inserted (COMPUTATIONAL). This value will be zero if no key was found.

data-name-3 is the area into which the actual size, in bytes, of the last record read or written will be inserted (COMPUTATIONAL). This parameter is optional.

3. Set a file to keyed sequential access and position to a specified key value. The user who wishes to process a keyed file sequentially is required to specify "ACCESS IS SEQUENTIAL". The user is expected to open the file as sequential and then call upon this routine to redefine it as "keyed sequential". The file will then be positioned to the specified key value and a return will be made to the user program where reading will proceed sequentially. If a record exists whose key matches the specified value, it will be the first record accessed by the next sequential read. If the specified key is not in the file, the next sequential read will access the first record with a higher key value.

User Syntax:

ENTER START file-name, data-name-1, data-name-2

where

START is the entry point in the run-time routine.

file-name is the appropriate FD name (SEQUENTIAL).

data-name-1 contains the monitor record key (DISPLAY).

data-name-2 contains the length of data-name-1 (COMPUTATIONAL).

Note that the redefinition of the consecutive file to keyed sequential occurs by executing an M:CLOSE and then an M:OPEN.

4. Skip n records in a file.

Uses the monitor PRECORD routine to skip forward over the specified number of records. If the file is monitor formatted, n logical records will be bypassed; if user formatted, n physical records will be skipped. This routine does not allow skipping from the middle of a physical record in a user-formatted file, nor does it account for blocks already in memory due to double buffering. The user is responsible for reducing his skip count in such a situation.

User Syntax:

ENTER SKIP file-name, data-name-1[, procedure-name]

where

SKIP is the entry point in the run-time routine.

file-name is the appropriate FD name.

data-name-1 contains the number of records to skip (COMPUTATIONAL). A negative number indicates reversed skipping. The number of records yet to be skipped will be stored in data-name-1 upon completion.

procedure-name is to be executed if either of the following abnormal conditions occurs: end-of-file, end-of-tape (user-formatted file). The number of records yet to be skipped is placed in the actual record size field (ARS) of the associated DCB. This parameter is optional.

5. Close and release disk file to the monitor.

This routine closes and releases disk files to the monitor when the COBOL programmer is through using them.

User Syntax:

ENTER RELFILES file-name-1, file-name-2, ..., file-name-n

where

RELFILES is the entry point in the run-time routine.

file-name-1 is an appropriate FD name.

:

:

file-name-n is the last of multiple files to be closed and released.

6. Get current date, time, and sense switch settings.

This routine picks up the current date, time, and sense switch settings, and makes them available to the user program. The routine optionally picks up the current number of lines per page from a printer DCB. This value is set by the (LINES, value) parameter in the !ASSIGN card.

User Syntax:

ENTER GETCOM data-name-1[, print-file-name]

where

GETCOM is the entry point in the run-time routine.

data-name-1 is a 26-byte area (DISPLAY) into which will be inserted the following information:

bytes 1-6 the pseudo-switch settings; 0 is off, 1 is on.

bytes 7-8 blank.

bytes 9-24 time and date, in the monitor form HH:MM MON DD, 'YY (hours, minutes, month, day, year).

bytes 25-26 number of lines per page in the printer DCB.

print-file-name is the appropriate FD name corresponding to the printer DCB.

7. Transform data to new collating sequence.

Allows the user to translate up to 255 bytes of data to any specified collating sequence. The user is responsible for constructing a 256-byte table containing the target collating sequence. The run-time routine uses the Translate Byte String instruction to accomplish the transformation. The target translation table is defined by the user in much the same way that key translation is specified in the Sigma Sort.

User Syntax:

ENTER TRANSFORM data-name-1, data-name-2, data-name-3

where

TRANSFORM is the entry point in the run-time routine.

data-name-1 contains up to 255 bytes of data to be transformed (DISPLAY).

data-name-2 contains the actual length of the byte string to be transformed (COMPUTATIONAL).

data-name-3 is a 256-byte translation table containing the target collating sequence. Data-name-1 and data-name-3 must start on word boundaries.

8. Set a data area to zero.

Allows the user to background large data areas to EBCDIC zero ('F0').

User Syntax:

ENTER SETZERO data-name-1, data-name-2

where

SETZERO is the entry point in the run-time routine.

data-name-1 is the area to set to zero (DISPLAY).

data-name-2 is the byte length of the area to be set to zero (COMPUTATIONAL). Maximum value is 32,767.

9. Set a data area to blanks.

Allows the user to background large data areas to EBCDIC blank ('40').

User Syntax:

ENTER SETBLANK data-name-1, data-name-2

where

SETBLANK is the entry point in the run-time routine.

data-name-1 is the area to be set to blanks (DISPLAY).

data-name-2 is the byte length of the area to be set to blanks (COMPUTATIONAL). Maximum value is 32,767.

10. Signal operator to change printer form or punch card stock.

Allows the user to request a change in the form used on the specified output device (card punch or line printer). Any message, up to 255 bytes long, may be inserted into the output symbiont stream. The message, generally directions to the computer operator, is automatically intercepted at actual print (or punch) time, directed to the operator's console, and the output symbiont is suspended. Upon performance of the action specified in the user programmer's message, the symbiont can be restarted and printing or punching continued. Note that a second message is required later to cause restoration of a "standard" form for the next job.

User Syntax:

ENTER FORMESS file-name, data-name-1, data-name-2

where

FORMESS is the entry point in the run-time routine.

file-name is the appropriate output FD name.

data-name-1 is the message to be inserted in the print or punch output symbiont (DISPLAY).

data-name-2 is the length of the message (COMPUTATIONAL). Maximum value is 255.

COBOL Error Codes

In addition to the error and abnormal returns documented in the appropriate BPM/CP-V monitor reference manuals, code numbers 80 through 9F (hexadecimal) are reserved for the COBOL compiler and object programs. Table 4 defines these codes.

Table 4. COBOL Error Codes

Code (Hexadecimal)	Procedure Name	Meaning
01	OPEN	Opening a DCB with insufficient information.
03	OPEN	Nonexistent name.
04	PRECORD READ	Beginning of file.
07	READ	Lost data (buffer size smaller than record read).

Table 4. COBOL Error Codes (cont.)

Code (Hexadecimal)	Procedure Name	Meaning
0A	CLOSE	Closing an unopened file.
13	WRITE DELREC	Requested key not found on an UPDATE file.
14	OPEN	Insufficient information to identify a file.
15	WRITE DELREC	Illegal sequence of operations on an INOUT file.
16	WRITE	NEWKEY option specified on already existing key.
17	WRITE	NEWKEY option not specified on key for OUT or OUTIN files.
18	WRITE	KEY not in proper sequence.
1C	READ WRITE PRECORD	End of tape.
1D	READ PRECORD	Beginning of tape.
2E	OPEN	Opening an open file.
80	READ/WRITE	Request to READ/WRITE an unopened file.
82	OPEN	Unable to obtain dynamic area for blocking/deblocking.
86	READ	Logical Record read is larger than maximum size (MAXSIZE) specification in COBOL program.
87	READ	The sum of the record prefix count is not equal to the block prefix count.
88	READ	The block prefix count does not agree with the actual record size read by the system (ARS).
89	WRITE	User is attempting to write a logical record that is too large for his blocking buffer (a logical record cannot be greater than eight bytes smaller than maximum blocksize).
8C	GCP ¹	Common page not available.
8D	Object Pro- gram Sort ²	Sort error.
8F	OPEN	Opening a locked file.
90	Report Writer ³ GENERATE TERMINATE	Report not initiated.
91	Report Writer ³ INITIATE	Report already initiated.

Table 4. COBOL Error Codes (cont.)

Code (Hexadecimal)	Procedure Name	Meaning
92	Report Writer ³	Incompatible line spacing.
99	C:VPL	Value of data-name in OCCURS DEPENDING ON clause exceeds the maximum specified.
9A	Object Program ENTER	Invalid calling sequence for run-time library subroutine.
9E	Object Program ⁴	Erroneous transfer of control.
9F	Compiler	Internal I/O errors.

Notes:

- 1 SR1 contains zero.
- 2 R6 contains one of the following values:
 - 01 (Sort error – in and out record count out of balance)
 - 02 (Sort aborted – I/O error)
 - 03 (Sort aborted – specification error)
 - 04 (Sort aborted – registers give reason)
 - 05 (Sort aborted – memory overflow)
 - 06 (Sort aborted – illegal own-code action request)
 - 07 (Reserved for future use)
 - 08 (Sort aborted – illegal decimal key)
 - 09 (Sort error – sequence error in output file)
- 3 SR1 contains location of call to C:RRG; SR3 (bytes 1 through 3) contains address of Report Table (R:report-name).
- 4 No register settings are significant.

The only COBOL run-time diagnostic is of the form

PROGRAM ABORTED--ERROR CODE nn nn

xxxxx IS FD-NAME

REL. INST. LOCATION IS yyyyyyyy

where

nn nn is the appropriate 4-digit error code and subcode number.

xxxxx is the name of the file.

yyyyyyyy is the relative location of the instruction causing the error.

In each case that an error is incurred, the action taken is to abort the current job. The STEP condition code is set to 6. (Refer to the CP-V Batch Processing Reference Manual, 90 17 64, for the STEP command.)

The error code is contained in byte 0 of SR3. Except where footnoted above, the DCB address is contained in bytes 1 through 3 of SR3 and the location following the associated CALL instruction is communicated in SR1.

APPENDIX. REFERENCE TABLES

This appendix contains the following reference material:

Title

Standard Symbols and Codes

Standard 8-Bit Computer Codes (EBCDIC)

Standard 7-Bit Communication Codes (ANSII)

Standard Symbol-Code Correspondences

Hexadecimal Arithmetic

Addition Table

Multiplication Table

Table of Powers of Sixteen₁₀

Table of Powers of Ten₁₆

Hexadecimal-Decimal Integer Conversion Table

Hexadecimal-Decimal Fraction Conversion Table

Table of Powers of Two

Mathematical Constants

STANDARD SYMBOLS AND CODES

The symbol and code standards described in this publication are applicable to all Xerox computer products, both hardware and software. They may be expanded or altered from time to time to meet changing requirements.

The symbols listed here include two types: graphic symbols and control characters. Graphic symbols are displayable and printable; control characters are not. Hybrids are SP, the symbol for a blank space; and DEL, the delete code, which is not considered a control command.

Three types of code are shown: (1) the 8-bit Xerox Standard Computer Code, i.e., the Extended Binary-Coded-Decimal Interchange Code (EBCDIC); (2) the 7-bit American National Standard Code for Information Interchange (ANSII); and (3) the Xerox standard card code.

STANDARD CHARACTER SETS

1. EBCDIC

57-character set: uppercase letters, numerals, space, and & - / . < > () + ! \$ * : ; , % # @ ' =

63-character set: same as above plus / ! _ ? " ~

89-character set: same as 63-character set plus lowercase letters

2. ANSCII

64-character set: uppercase letters, numerals, space, and ! " \$ % & ' () * + , - . / \ ; : = < > ? @ [] ^ #

95-character set: same as above plus lowercase letters and { } | ~ `

CONTROL CODES

In addition to the standard character sets listed above, the symbol repertoire includes 37 control codes and the hybrid code DEL (hybrid code SP is considered part of all character sets). These are listed in the table titled Standard Symbol-Code Correspondences.

SPECIAL CODE PROPERTIES

The following two properties of all standard codes will be retained for future standard code extensions:

1. All control codes, and only the control codes, have their two high-order bits equal to "00". DEL is not considered a control code.
2. No two graphic EBCDIC codes have their seven low-order bits equal.

STANDARD 8-BIT COMPUTER CODES (EBCDIC)

Hexadecimal		Most Significant Digits															
		0	1	2	3	4	5	6	7	8	9	A	B	C	D	E	F
Binary		0000	0001	0010	0011	0100	0101	0110	0111	1000	1001	1010	1011	1100	1101	1110	1111
Least Significant Digits	0	0000	NUL	DLE	ds	SP	&	-	/								0
	1	0001	SOH	DC1	ss	/	/	/	/	a	j	\		A	J		1
	2	0010	STX	DC2	fs	/	/	/	/	b	k	s	{	B	K	S	2
	3	0011	ETX	DC3	si	/	/	/	/	c	l	t	}	C	L	T	3
	4	0100	EOT	DC4		/	/	/	/	d	m	u	[D	M	U	4
	5	0101	HT	LF NL		Will not be assigned				e	n	v]	E	N	V	5
	6	0110	ACK	SYN		/	/	/	/	f	o	w		F	O	W	6
	7	0111	BEL	ETB		/	/	/	/	g	p	x		G	P	X	7
	8	1000	EOM BS	CAN		/	/	/	/	h	q	y		H	Q	Y	8
	9	1001	ENQ	EM		/	/	/	/	i	r	z		I	R	Z	9
	A	1010	NAK	SUB		^		~	:								
	B	1011	VT	ESC		.	\$,	#								
	C	1100	FF	FS		<	*	%	@					Will not be assigned			
	D	1101	CR	GS		()	_	'								
	E	1110	SO	RS		+	;	>	=								
	F	1111	SI	US			~	?	"								DEL

NOTES:

- The characters ^ \ { } [] are ANSCII characters that do not appear in any of the EBCDIC-based character sets, though they are shown in the EBCDIC table.
- The characters ^ | ~ appear in the 63- and 89-character EBCDIC sets but not in either of the ANSCII-based sets. However, Xerox software translates the characters c into ANSCII characters as follows:

EBCDIC	=	ANSSCII
^	=	\ (6-0)
	=	(7-12)
~	=	~ (7-14)

- The EBCDIC control codes in columns 0 and 1 and their binary representation are exactly the same as those in the ANSCII table, except for two interchanges: LF/NL with NAK, and HT with ENQ.
- Characters enclosed in heavy lines are included only in the standard 63- and 89-character EBCDIC sets.
- These characters are included only in the standard 89-character EBCDIC set.

STANDARD 7-BIT COMMUNICATION CODES (ANSII) ¹

Decimal (rows)		Most Significant Digits								
		0	1	2	3	4	5	6	7	
Binary (col's.)		x000	x001	x010	x011	x100	x101	x110	x111	
Least Significant Digits	0	0000	NUL	DLE	SP	0	@	P	\	p
	1	0001	SOH	DC1	!	1	A	Q	a	q
	2	0010	STX	DC2	"	2	B	R	b	r
	3	0011	ETX	DC3	#	3	C	S	c	s
	4	0100	EOT	DC4	\$	4	D	T	d	t
	5	0101	ENQ	NAK	%	5	E	U	e	u
	6	0110	ACK	SYN	&	6	F	V	f	v
	7	0111	BEL	ETB	'	7	G	W	g	w
	8	1000	BS	CAN	(8	H	X	h	x
	9	1001	HT	EM)	9	I	Y	i	y
	10	1010	LF NL	SUB	*	:	J	Z	j	z
	11	1011	VT	ESC	+	;	K	[k	{
	12	1100	FF	FS	,	<	L	\	l	
	13	1101	CR	GS	-		M]	m	}
	14	1110	SO	RS	.	>	N	^	n	~
	15	1111	SI	US	/	?	O	_	o	DEL

NOTES:

- Most significant bit, added for 8-bit format, is either 0 or even parity.
- Columns 0-1 are control codes.
- Columns 2-5 correspond to the 64-character ANSCII set. Columns 2-7 correspond to the 95-character ANSCII set.
- On many current teletypes, the symbol
 - ^ is | (5-14)
 - _ is - (5-15)
 - ~ is ESC or ALTMODE control (7-14)

and none of the symbols appearing in columns 6-7 are provided. Except for the three symbol differences noted above, therefore, such teletypes provide all the characters in the 64-character ANSCII set. (The Xerox 7015 Remote Keyboard Printer provides the 64-character ANSCII set also, but prints ^ as A.)

- On the Xerox 7670 Remote Batch Terminal, the symbol
 - | is | (2-1)
 - [is ^ (5-11)
 -] is | (5-13)
 - ^ is ~ (5-14)

and none of the symbols appearing in columns 6-7 are provided. Except for the four symbol differences noted above, therefore, this terminal provides all the characters in the 64-character ANSCII set.

STANDARD SYMBOL-CODE CORRESPONDENCES

EBCDIC [†]		Symbol	Card Code	ANSII ^{††}	Meaning	Remarks
Hex.	Dec.					
00	0	NUL	12-0-9-8-1	0-0	null	00 through 23 and 2F are control codes. EOM is used only on Xerox Keyboard/Printers Models 7012, 7020, 8091, and 8092.
01	1	SOH	12-9-1	0-1	start of header	
02	2	STX	12-9-2	0-2	start of text	
03	3	ETX	12-9-3	0-3	end of text	
04	4	EOT	12-9-4	0-4	end of transmission	
05	5	HT	12-9-5	0-9	horizontal tab	
06	6	ACK	12-9-6	0-6	acknowledge (positive)	
07	7	BEL	12-9-7	0-7	bell	
08	8	BS or EOM	12-9-8	0-8	backspace or end of message	
09	9	ENQ	12-9-8-1	0-5	enquiry	
0A	10	NAK	12-9-8-2	1-5	negative acknowledge	
0B	11	VT	12-9-8-3	0-11	vertical tab	
0C	12	FF	12-9-8-4	0-12	form feed	
0D	13	CR	12-9-8-5	0-13	carriage return	
0E	14	SO	12-9-8-6	0-14	shift out	
0F	15	SI	12-9-8-7	0-15	shift in	
10	16	DLE	12-11-9-8-1	1-0	data link escape	Replaces characters with parity error.
11	17	DC1	11-9-1	1-1	device control 1	
12	18	DC2	11-9-2	1-2	device control 2	
13	19	DC3	11-9-3	1-3	device control 3	
14	20	DC4	11-9-4	1-4	device control 4	
15	21	LF or NL	11-9-5	0-10	line feed or new line	
16	22	SYN	11-9-6	1-6	sync	
17	23	ETB	11-9-7	1-7	end of transmission block	
18	24	CAN	11-9-8	1-8	cancel	
19	25	EM	11-9-8-1	1-9	end of medium	
1A	26	SUB	11-9-8-2	1-10	substitute	
1B	27	ESC	11-9-8-3	1-11	escape	
1C	28	FS	11-9-8-4	1-12	file separator	
1D	29	GS	11-9-8-5	1-13	group separator	
1E	30	RS	11-9-8-6	1-14	record separator	
1F	31	US	11-9-8-7	1-15	unit separator	
20	32	ds	11-0-9-8-1		digit selector	20 through 23 are used with Sigma EDIT BYTE STRING (EBS) instruction - not input/output control codes. 24 through 2E are unassigned.
21	33	ss	0-9-1		significance start	
22	34	fs	0-9-2		field separation	
23	35	si	0-9-3		immediate significance start	
24	36		0-9-4			
25	37		0-9-5			
26	38		0-9-6			
27	39		0-9-7			
28	40		0-9-8			
29	41		0-9-8-1			
2A	42		0-9-8-2			
2B	43		0-9-8-3			
2C	44		0-9-8-4			
2D	45		0-9-8-5			
2E	46		0-9-8-6			
2F	47		0-9-8-7			
30	48		12-11-0-9-8-1			30 through 3F are unassigned.
31	49		9-1			
32	50		9-2			
33	51		9-3			
34	52		9-4			
35	53		9-5			
36	54		9-6			
37	55		9-7			
38	56		9-8			
39	57		9-8-1			
3A	58		9-8-2			
3B	59		9-8-3			
3C	60		9-8-4			
3D	61		9-8-5			
3E	62		9-8-6			
3F	63		9-8-7			

[†]Hexadecimal and decimal notation.

^{††}Decimal notation (column-row).

STANDARD SYMBOL-CODE CORRESPONDENCES (cont.)

EBCDIC [†]		Symbol	Card Code	ANSII ^{††}	Meaning	Remarks	
Hex.	Dec.						
40	64	SP	blank	2-0	blank	41 through 49 will not be assigned.	
41	65		12-0-9-1				
42	66		12-0-9-2				
43	67		12-0-9-3				
44	68		12-0-9-4				
45	69		12-0-9-5				
46	70		12-0-9-6				
47	71		12-0-9-7				
48	72		12-0-9-8				
49	73		12-8-1				
4A	74	¸ or `	12-8-2	6-0	cent or accent grave	Accent grave used for left single quote. On model 7670, ` not available, and ¸ = ANSCII 5-11.	
4B	75		12-8-3	2-14	period		
4C	76		<	12-8-4	3-12		less than
4D	77		(12-8-5	2-8		left parenthesis
4E	78		+	12-8-6	2-11		plus
4F	79		or ¡	12-8-7	7-12		vertical bar or broken bar
50	80	&	12	2-6	ampersand	51 through 59 will not be assigned.	
51	81		12-11-9-1				
52	82		12-11-9-2				
53	83		12-11-9-3				
54	84		12-11-9-4				
55	85		12-11-9-5				
56	86		12-11-9-6				
57	87		12-11-9-7				
58	88		12-11-9-8				
59	89		11-8-1				
5A	90	!	11-8-2	2-1	exclamation point	On Model 7670, ! is I.	
5B	91		\$	11-8-3	2-4		dollars
5C	92		*	11-8-4	2-10		asterisk
5D	93)	11-8-5	2-9		right parenthesis
5E	94		;	11-8-6	3-11		semicolon
5F	95		~ or ¬	11-8-7	7-14		tilde or logical not
60	96	-	11	2-13	minus, dash, hyphen	62 through 69 will not be assigned.	
61	97		/	0-1	2-15		slash
62	98			11-0-9-2			
63	99			11-0-9-3			
64	100			11-0-9-4			
65	101			11-0-9-5			
66	102			11-0-9-6			
67	103			11-0-9-7			
68	104			11-0-9-8			
69	105			0-8-1			
6A	106	^	12-11	5-14	circumflex	On Model 7670 ^ is ~. On Model 7015 ^ is ^ (caret).	
6B	107		,	0-8-3	2-12		comma
6C	108		%	0-8-4	2-5		percent
6D	109		_	0-8-5	5-15		underline
6E	110		>	0-8-6	3-14		greater than
6F	111		?	0-8-7	3-15		question mark
70	112	:	12-11-0			70 through 79 will not be assigned.	
71	113			12-11-0-9-1			
72	114			12-11-0-9-2			
73	115			12-11-0-9-3			
74	116			12-11-0-9-4			
75	117			12-11-0-9-5			
76	118			12-11-0-9-6			
77	119			12-11-0-9-7			
78	120			12-11-0-9-8			
79	121			8-1			
7A	122	#	8-2	3-10	colon		
7B	123		8-3	2-3	number		
7C	124		@	8-4	4-0		at
7D	125		'	8-5	2-7		apostrophe (right single quote)
7E	126		=	8-6	3-13		equals
7F	127		"	8-7	2-2		quotation mark

[†] Hexadecimal and decimal notation.

^{††} Decimal notation (column-row).

STANDARD SYMBOL-CODE CORRESPONDENCES (cont.)

EBCDIC ^f		Symbol	Card Code	ANSII ^{tt}	Meaning	Remarks
Hex.	Dec.					
80	128	a	12-0-8-1	6-1		80 is unassigned. 81-89, 91-99, A2-A9 comprise the lowercase alphabet. Available only in standard 89- and 95-character sets.
81	129					
82	130					
83	131					
84	132					
85	133					
86	134					
87	135					
88	136					
89	137					
8A	138		12-0-8-2			8A through 90 are unassigned.
8B	139					
8C	140					
8D	141					
8E	142					
8F	143					
90	144					
91	145					
92	146	j	12-11-8-1	6-10		9A through A1 are unassigned.
93	147					
94	148					
95	149					
96	150					
97	151					
98	152					
99	153					
9A	154					
9B	155					
9C	156	k	12-11-1	6-11		
9D	157					
9E	158					
9F	159					
A0	160					
A1	161					
A2	162					
A3	163					
A4	164					
A5	165					
A6	166					
A7	167					
A8	168					
A9	169					
AA	170					
AB	171					
AC	172					
AD	173					
AE	174					
AF	175					
B0	176	l	11-0-8-1	7-3		AA through B0 are unassigned.
B1	177					
B2	178					
B3	179					
B4	180					
B5	181					
B6	182					
B7	183					
B8	184					
B9	185					
BA	186	m	11-0-1	7-4		
BB	187					
BC	188					
BD	189					
BE	190					
BF	191					
B0	176	n	11-0-2	7-5		
B1	177					
B2	178					
B3	179					
B4	180					
B5	181					
B6	182					
B7	183					
B8	184					
B9	185					
BA	186	o	11-0-3	7-6		
BB	187					
BC	188					
BD	189					
BE	190					
BF	191					
B0	176	p	11-0-4	7-7		
B1	177					
B2	178					
B3	179					
B4	180					
B5	181					
B6	182					
B7	183					
B8	184					
B9	185					
BA	186	q	11-0-5	7-8		
BB	187					
BC	188					
BD	189					
BE	190					
BF	191					
B0	176	r	11-0-6	7-9		
B1	177					
B2	178					
B3	179					
B4	180					
B5	181					
B6	182					
B7	183					
B8	184					
B9	185					
BA	186	s	11-0-7	7-10		
BB	187					
BC	188					
BD	189					
BE	190					
BF	191					
B0	176	t	11-0-8-1	5-12	backslash	On Model 7670, [is g. On Model 7670,] is l. B6 through BF are unassigned.
B1	177					
B2	178					
B3	179					
B4	180					
B5	181					
B6	182					
B7	183					
B8	184					
B9	185					
BA	186	}	11-0-8-2	5-11	left brace	
BB	187					
BC	188					
BD	189					
BE	190					
BF	191					
B0	176	}	11-0-8-3	5-13	right brace	
B1	177					
B2	178					
B3	179					
B4	180					
B5	181					
B6	182					
B7	183					
B8	184					
B9	185					
BA	186	[11-0-8-4		right bracket	
BB	187					
BC	188					
BD	189					
BE	190					
BF	191					
B0	176]	11-0-8-5			
B1	177					
B2	178					
B3	179					
B4	180					
B5	181					
B6	182					
B7	183					
B8	184					
B9	185					
BA	186	^	11-0-8-6			
BB	187					
BC	188					
BD	189					
BE	190					
BF	191					
B0	176	_	11-0-8-7			
B1	177					
B2	178					
B3	179					
B4	180					
B5	181					
B6	182					
B7	183					
B8	184					
B9	185					
BA	186	`	11-0-8-7			
BB	187					
BC	188					
BD	189					
BE	190					
BF	191					

^f Hexadecimal and decimal notation.

^{tt} Decimal notation (column-row).

STANDARD SYMBOL-CODE CORRESPONDENCES (cont.)

EBCDIC†		Symbol	Card Code	ANSII††	Meaning	Remarks
Hex.	Dec.					
C0	192		12-0			C0 is unassigned. C1-C9, D1-D9, E2-E9 comprise the uppercase alphabet. CA through CF will not be assigned.
C1	193	A	12-1	4-1		
C2	194	B	12-2	4-2		
C3	195	C	12-3	4-3		
C4	196	D	12-4	4-4		
C5	197	E	12-5	4-5		
C6	198	F	12-6	4-6		
C7	199	G	12-7	4-7		
C8	200	H	12-8	4-8		
C9	201	I	12-9	4-9		
CA	202		12-0-9-8-2			
CB	203		12-0-9-8-3			
CC	204		12-0-9-8-4			
CD	205		12-0-9-8-5			
CE	206		12-0-9-8-6			
CF	207		12-0-9-8-7			
D0	208		11-0			D0 is unassigned. DA through DF will not be assigned.
D1	209	J	11-1	4-10		
D2	210	K	11-2	4-11		
D3	211	L	11-3	4-12		
D4	212	M	11-4	4-13		
D5	213	N	11-5	4-14		
D6	214	O	11-6	4-15		
D7	215	P	11-7	5-0		
D8	216	Q	11-8	5-1		
D9	217	R	11-9	5-2		
DA	218		12-11-9-8-2			
DB	219		12-11-9-8-3			
DC	220		12-11-9-8-4			
DD	221		12-11-9-8-5			
DE	222		12-11-9-8-6			
DF	223		12-11-9-8-7			
E0	224		0-8-2			E0, E1 are unassigned. EA through EF will not be assigned.
E1	225		11-0-9-1			
E2	226	S	0-2	5-3		
E3	227	T	0-3	5-4		
E4	228	U	0-4	5-5		
E5	229	V	0-5	5-6		
E6	230	W	0-6	5-7		
E7	231	X	0-7	5-8		
E8	232	Y	0-8	5-9		
E9	233	Z	0-9	5-10		
EA	234		11-0-9-8-2			
EB	235		11-0-9-8-3			
EC	236		11-0-9-8-4			
ED	237		11-0-9-8-5			
EE	238		11-0-9-8-6			
EF	239		11-0-9-8-7			
F0	240	0	0	3-0		FA through FE will not be assigned. Special — neither graphic nor control symbol.
F1	241	1	1	3-1		
F2	242	2	2	3-2		
F3	243	3	3	3-3		
F4	244	4	4	3-4		
F5	245	5	5	3-5		
F6	246	6	6	3-6		
F7	247	7	7	3-7		
F8	248	8	8	3-8		
F9	249	9	9	3-9		
FA	250		12-11-0-9-8-2			
FB	251		12-11-0-9-8-3			
FC	252		12-11-0-9-8-4			
FD	253		12-11-0-9-8-5			
FE	254		12-11-0-9-8-6			
FF	255	DEL	12-11-0-9-8-7		delete	

† Hexadecimal and decimal notation.

†† Decimal notation (column-row).

HEXADECIMAL ARITHMETIC

ADDITION TABLE

0	1	2	3	4	5	6	7	8	9	A	B	C	D	E	F
1	02	03	04	05	06	07	08	09	0A	0B	0C	0D	0E	0F	10
2	03	04	05	06	07	08	09	0A	0B	0C	0D	0E	0F	10	11
3	04	05	06	07	08	09	0A	0B	0C	0D	0E	0F	10	11	12
4	05	06	07	08	09	0A	0B	0C	0D	0E	0F	10	11	12	13
5	06	07	08	09	0A	0B	0C	0D	0E	0F	10	11	12	13	14
6	07	08	09	0A	0B	0C	0D	0E	0F	10	11	12	13	14	15
7	08	09	0A	0B	0C	0D	0E	0F	10	11	12	13	14	15	16
8	09	0A	0B	0C	0D	0E	0F	10	11	12	13	14	15	16	17
9	0A	0B	0C	0D	0E	0F	10	11	12	13	14	15	16	17	18
A	0B	0C	0D	0E	0F	10	11	12	13	14	15	16	17	18	19
B	0C	0D	0E	0F	10	11	12	13	14	15	16	17	18	19	1A
C	0D	0E	0F	10	11	12	13	14	15	16	17	18	19	1A	1B
D	0E	0F	10	11	12	13	14	15	16	17	18	19	1A	1B	1C
E	0F	10	11	12	13	14	15	16	17	18	19	1A	1B	1C	1D
F	10	11	12	13	14	15	16	17	18	19	1A	1B	1C	1D	1E

MULTIPLICATION TABLE

1	2	3	4	5	6	7	8	9	A	B	C	D	E	F
2	04	06	08	0A	0C	0E	10	12	14	16	18	1A	1C	1E
3	06	09	0C	0F	12	15	18	1B	1E	21	24	27	2A	2D
4	08	0C	10	14	18	1C	20	24	28	2C	30	34	38	3C
5	0A	0F	14	19	1E	23	28	2D	32	37	3C	41	46	4B
6	0C	12	18	1E	24	2A	30	36	3C	42	48	4E	54	5A
7	0E	15	1C	23	2A	31	38	3F	46	4D	54	5B	62	69
8	10	18	20	28	30	38	40	48	50	58	60	68	70	78
9	12	1B	24	2D	36	3F	48	51	5A	63	6C	75	7E	87
A	14	1E	28	32	3C	46	50	5A	64	6E	78	82	8C	96
B	16	21	2C	37	42	4D	58	63	6E	79	84	8F	9A	A5
C	18	24	30	3C	48	54	60	6C	78	84	90	9C	A8	B4
D	1A	27	34	41	4E	5B	68	75	82	8F	9C	A9	B6	C3
E	1C	2A	38	46	54	62	70	7E	8C	9A	A8	B6	C4	D2
F	1E	2D	3C	48	5A	69	78	87	96	A5	B4	C3	D2	E1

INDEX

Note: For each entry in this index, the number of the most significant page is listed first. Any pages thereafter are listed in numerical sequence.

A

ADVANCING clause, 18
ANS-labeled tapes, 3

B

basic setups, 20
binary calculations, 1
BO option, 7

C

character sets, 75
co-resident sort feature, 40
COBOL
 error codes, 72
 library on tape, 18
 object program subroutines, 65
 work files, 18
COMMON-STORAGE, 7, 14
communication codes (ANSCII), 76
compilation
 initiation, 6
 of large source programs, 18
compiler diagnostics, 49
computer codes (EBCDIC), 76
control codes, 75
CS option, 7

D

data division map listing, 7
DCB (data control block), 16
debug module object time switch, 48
DEBUG option, 7
decimal display fields, 1
deck structures, 20
DIAG option, 7
DMAP option, 7
DQ option, 9
dummy program sections, 16

E

ENTER
 DELETER, 69
 FORMESS, 72
 GETCOM, 71
 LASTKEY, 69

RELFILES, 70
SETBLANK, 72
SETZERO, 71
SKIP, 70
START, 70
 statement feature, 37
 subroutine-name statement, 68
TRANSFORM, 71
error codes, COBOL, 72
exponentiation, 1

F

file index areas, 17
file record areas, 17
FROM option of WRITE statement, 3

G

GO option, 9

H

hexadecimal arithmetic, 81

I

I/O considerations, 2
inter-program communication, 14, 31
INTO option of READ statement, 3

L

labeled tapes, 3
LIB option, 9
library subroutines, 65
LIMIT control command, 18
LO option, 9
load module map, 17
LS option, 9

M

MAIN option, 12
MAPS option, 12
mixed-mode arithmetic statements, 1

Note: For each entry in this index, the number of the most significant page is listed first. Any pages thereafter are listed in numerical sequence.

N

numeric data items, 1

O

object

listing, 9

program, 16

OCCURS DEPENDING ON clause, 2

output options, 6

P

packed decimal, 1

PMAP option, 12

POOL control command, 18

print file handling, 18

R

report areas, 17

root segment module, 17

run-time subroutines, services and diagnostics, 65

S

SAME RECORD AREA statement, 3

SEG option, 12

segmentation feature, 25

segmented object programs, 16

SEQCHK option, 12

sequential files, 2

SO option, 12

sort, 2

SRTx option, 13

source program and procedure division map listing, 11

special code properties, 75

special interfaces to hardware and monitor services, 68

SUB option, 13

subcompile feature, 31

subprogram calls, 68

subscripts, 1

symbol-code correspondences, 77

symbols and codes, 75

SYN option, 13

T

table handling, 2

TEST option, 13

TREE control command, 16

U

unlabeled tapes, 3

V

vertical-format-control codes, 19

W

WORKING-STORAGE SECTION, 15, 17

X

XREF option, 13

PLEASE FOLD AND TAPE--
NOTE: U. S. Postal Service will not deliver stapled forms



NO POSTAGE
NECESSARY
IF MAILED
IN THE
UNITED STATES

BUSINESS REPLY MAIL
FIRST CLASS PERMIT NO. 59153 LOS ANGELES, CA 90045

POSTAGE WILL BE PAID BY ADDRESSEE

HONEYWELL INFORMATION SYSTEMS
5250 W. CENTURY BOULEVARD
LOS ANGELES, CA 90045

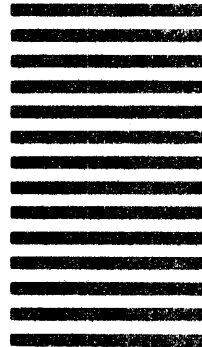

ATTN: PROGRAMMING PUBLICATIONS

Honeywell

CUT ALONG LINE
FOLD ALONG LINE
FOLD ALONG LINE

Honeywell Information Systems
In the U.S.A.: 200 Smith Street, MS 486, Waltham, Massachusetts 02154
In Canada: 2025 Sheppard Avenue East, Willowdale, Ontario M2J 1W5
In Mexico: Avenida Nuevo Leon 250, Mexico 11, D.F.

22228, 3C1178, Printed in U.S.A.

XJ80, Rev. 0